

KICH[®]

STEEL... FOR LIFE



PRICE LIST

W.E.F. 21 - 11 - 2021

Uplift your class with KICH S. S. 316 Grade Premium Quality Architectural Products



Accredited by :

Selected as :

www.kichindia.com

INDEX



Mortice Handle : **03 - 04**
(Marvel Collection & Elite Series)

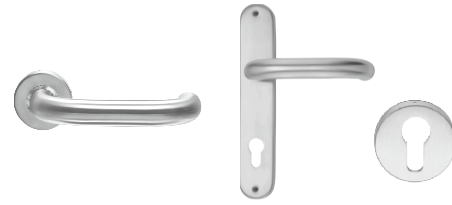

Mortice Handle I Mortice Handle with
Rectangle Cap I Escutcheons : **05 - 06**

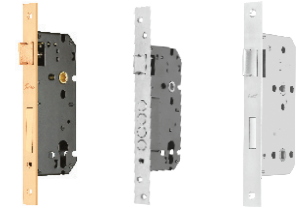

Mortice Lock Body : **07 - 08**



Pin Cylinder I Night Latch : **08 - 10**



Door and Window Hinges : **11**



Pull Handle : **12 - 14**



Door Closer I Drawer Slides : **15**

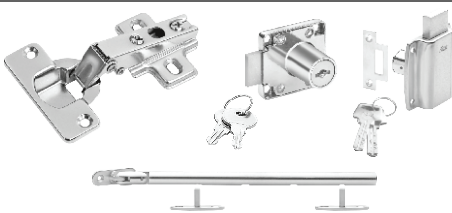

Clip on Hinges I Drawer & Cupboard Lock I
Window Casement Stay : **16**



Cabinet Handle I
Concealed Handle : **17 - 18**



Drawer Knobs I Door Stopper I
Door Stops I Door Viewer : **19**

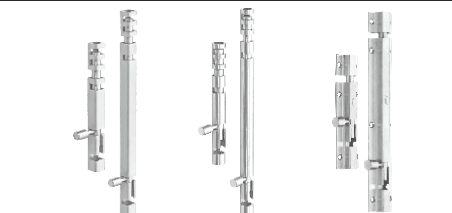

Tower Bolt : **20**



Digital Safe : **21**

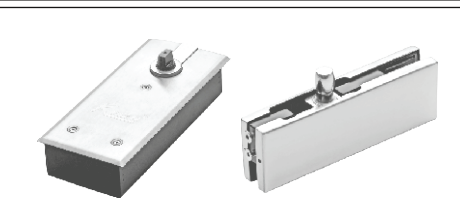

Floor Spring I Patch Fitting : **22**



Shower Hinges : **23**



Glass Connector I
Shower Cubicle Accessories : **24**

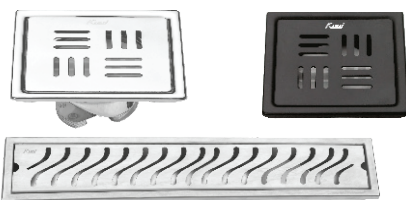

Floor Drains : **25 - 26**



Bathroom Accessories : **27 - 31**



STAINLESS STEEL AISI 316 GRADE MORTICE HANDLES **MARVEL COLLECTION**







Description	Size	Product	Code	Price per set		
				Glossy	Satin	Combi.
Mortice Handle Stainless Steel Finish	□ 32x8mm		MH1981S	-	-	-
Mortice Handle Gold PVD Finish	□ 32x8mm		MH1981PGS	-	-	-
Mortice Handle Copper PVD Finish	□ 32x8mm		MH1981PCS	-	-	-
Mortice Handle Antique Finish	□ 32x8mm		MH1981ATS	-	-	-
Mortice Handle Stainless Steel Finish	□ 35x6mm		MH1982S	-	-	-
Mortice Handle Gold PVD Finish	□ 35x6mm		MH1982PGS	-	-	-
Mortice Handle Copper PVD Finish	□ 35x6mm		MH1982PCS	-	-	-
Mortice Handle Antique Finish	□ 35x6mm		MH1982ATS	-	-	-
Mortice Handle Stainless Steel Finish	□ 39x8mm		MH1983S	-	-	-
Mortice Handle Gold PVD Finish	□ 39x8mm		MH1983PGS	-	-	-
Mortice Handle Copper PVD Finish	□ 39x8mm		MH1983PCS	-	-	-
Mortice Handle Antique Finish	□ 39x8mm		MH1983ATS	-	-	-
Mortice Handle Gold PVD Finish + White Powder Coating	Ø 32mm		MH1934WPGS	-	-	-
Mortice Handle Copper PVD Finish + White Powder Coating	Ø 32mm		MH1934WPCS	-	-	-
Mortice Handle Antique Finish + White Powder Coating	Ø 32mm		MH1934WATS	-	-	-
Mortice Handle Stainless Steel Finish	□ 25x6mm		MH1976S	-	-	-
Mortice Handle Copper PVD Finish	□ 25x6mm		MH1976PCS	-	-	-
Mortice Handle Black PVD Finish	□ 25x6mm		MH1976PBS	-	-	-
Mortice Handle Antique Finish	□ 25x6mm		MH1976ATS	-	-	-
Mortice Handle Stainless Steel Finish	□ 22x8mm		MH1977S	-	-	-
Mortice Handle Copper PVD Finish	□ 22x8mm		MH1977PCS	-	-	-
Mortice Handle Black PVD Finish	□ 22x8mm		MH1977PBS	-	-	-
Mortice Handle Antique Finish	□ 22x8mm		MH1977ATS	-	-	-
Mortice Handle Stainless Steel Finish	Ø 32x16mm		MH1979S	-	-	-
Mortice Handle Copper PVD Finish	Ø 32x16mm		MH1979PCS	-	-	-
Mortice Handle Black PVD Finish	Ø 32x16mm		MH1979PBS	-	-	-
Mortice Handle Antique Finish	Ø 32x16mm		MH1979ATS	-	-	-

STAINLESS STEEL AISI 316 GRADE MORTICE HANDLES **ELITE SERIES**

Mortice Handle Stainless Steel Finish	□ 29x6		MH1963S	-	-	-
Mortice Handle Gold PVD Finish	□ 29x6		MH1963PGS	-	-	-
Mortice Handle Copper PVD Finish	□ 29x6		MH1963PCS	-	-	-
Mortice Handle Zirconium PVD Finish	□ 29x6		MH1963PZS	-	-	-
Mortice Handle Black PVD Finish	□ 29x6		MH1963PBS	-	-	-
Mortice Handle Brown PVD Finish	□ 29x6		MH1963PBRS	-	-	-
Mortice Handle Antique Finish	□ 29x6		MH1963ATS	-	-	-
Mortice Handle Black Powder Coating	□ 29x6		MH1963PWBS	-	-	-
Mortice Handle White Powder Coating	□ 29x6		MH1963PWWS	-	-	-













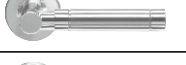
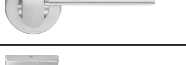

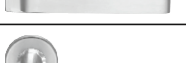





STAINLESS STEEL AISI 316 GRADE MORTICE HANDLES **ELITE SERIES**

Description	Size	Product	Code	Price per set		
				Glossy	Satin	Combi.
Mortice Handle Stainless Steel Finish	Ø 22 mm		MH2221S	-		-
Mortice Handle Gold PVD Finish	Ø 22 mm		MH2221PGS	-		-
Mortice Handle Copper PVD Finish	Ø 22 mm		MH2221PCS	-		-
Mortice Handle Zirconium PVD Finish	Ø 22 mm		MH2221PZS	-		-
Mortice Handle Black PVD Finish	Ø 22 mm		MH2221PBS	-		-
Mortice Handle Brown PVD Finish	Ø 22 mm		MH2221PBRS	-		-
Mortice Handle Antique Finish	Ø 22 mm		MH2221ATS	-		-
Mortice Handle Black Powder Coating	Ø 22 mm		MH2221PWBS	-		-
Mortice Handle White Powder Coating	Ø 22 mm		MH2221PWWS	-		-
Mortice Handle Stainless Steel Finish	□ 30 x 6		MH1965S	-		-
Mortice Handle Gold PVD Finish	□ 30 x 6		MH1965PGS	-		-
Mortice Handle Copper PVD Finish	□ 30 x 6		MH1965PCS	-		-
Mortice Handle Zirconium PVD Finish	□ 30 x 6		MH1965PZS	-		-
Mortice Handle Black PVD Finish	□ 30 x 6		MH1965PBS	-		-
Mortice Handle Brown PVD Finish	□ 30 x 6		MH1965PBRS	-		-
Mortice Handle Antique Finish	□ 30 x 6		MH1965ATS	-		-
Mortice Handle Black Powder Coating	□ 30 x 6		MH1965PWBS	-		-
Mortice Handle White Powder Coating	□ 30 x 6		MH1965PWWS	-		-
Mortice Handle Gold PVD Finish	Ø 22 mm		MH2233PGC	-	-	-
Mortice Handle Gold PVD Finish	Ø 22 mm		MH2242PGS	-		-







STAINLESS STEEL AISI 316 GRADE MORTICE HANDLES









Description	Size	Product	Code	Price per set		
				Glossy	Satin	Combi.
Mortice Handle	Ø 19 mm		MH193	2301.00		-
Mortice Handle	Ø 19 mm		MH195	-		-
Mortice Handle	Ø 19 mm		MH197	-		-
Mortice Handle	Ø 19 mm		MH198C	-	-	-
Mortice Handle	Ø 19 mm		MH1910C	-	-	-
Mortice Handle	□ 19 mm		MH1914S	-		-
Mortice Handle	□ 19 mm		MH1915C	-	-	-
Mortice Handle	□ 19 mm		MH1916S	-		-
Mortice Handle	Ø 19 mm		MH1921S	-		-
Mortice Handle	Ø 19 mm		MH1922S	-		-
Mortice Handle	□ 19 mm		MH1923S	-		-
Mortice Handle	□ 22 mm		MH1964S	-		-
Mortice Handle	Ø 22 mm		MH223			-
Mortice Handle	Ø 22 mm		MH223F			-
Mortice Handle	Ø 22 mm		MH224			-
Mortice Handle	Ø 22 mm		MH225			-
Mortice Handle	Ø 22 mm		MH227			-
Mortice Handle	Ø 22 mm		MH229	-		-
Mortice Handle	Ø 22 mm		MH2211C	-	-	-
Mortice Handle	Ø 22 mm		MH2222S	-		-
Mortice Handle	Ø 22 mm		MH2231C	-	-	-

MH Rates are including the set of Escutcheons for Cylinders

STAINLESS STEEL AISI 316 GRADE MORTICE HANDLES

Description	Size	Product	Code	Price per set		
				Glossy	Satin	Combi.
Mortice Handle	Ø 22 mm		MH2233C	-	-	-
Mortice Handle	Ø 22 mm		MH2241S	-	-	-
Mortice Handle	Ø 22 mm		MH2242S	-	-	-
Mortice Handle	□ 30x8 mm		MH2249S	-	-	-
Mortice Handle	□ 39x8 mm		MH1953S	-	-	-

STAINLESS STEEL AISI 316 GRADE PLATE WITH MORTICE HANDLES



Oval Cap 72x32mm with MH223S		MH223OES	-	-	-
Rectangle Cap 225x40 mm with MH193		RC3SMH193S	-	-	-
Rectangle Cap 225x40 mm with MH197C		RC4CMH197C	-	-	-
Rectangle Designer Cap 200x40 mm with MH1915C		RC5CMH1915C	-	-	-
Rectangle Designer Cap 200x40 mm with MH2231C		RC7SMH2231C	-	-	-
Rectangle Cap 200x50mm with MH1914S		RC1SMH1914S	-	-	-
Square Plate 170x170x2 mm with MH223S		SP2SMH223S	-	-	-
Square Plate 200x170x2 mm with MH223S		SP3SMH223S	-	-	-

■ Note : Also Available In Required Sizes with Mortice Handles





















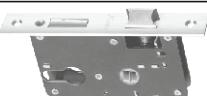

STAINLESS STEEL AISI 316 GRADE DOOR KNOB

Door Knob (Fixed Type) Ø 50 mm		DNR50	-	-	-
--------------------------------	---	-------	---	---	---

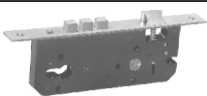
STAINLESS STEEL AISI 316 GRADE ESCUTCHEONS

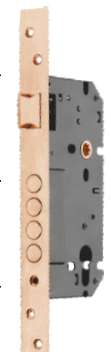
Europrofile - Round		EEP55S	-	-	-
Europrofile - Square		ESEP55S	-	-	-
Europrofile - Oval		EOEP55S	-	-	-







MORTICE LOCK BODY

Description	Size	Product	Code	Price per piece		
				Glossy	Satin	Combi.
Lock Body (S.S. Finish)	Back Set: 50x85			MLB92S	-	-
Lock Body (Gold PVD Finish)	Back Set: 50x85			MLB92PGS	-	-
Lock Body (Copper PVD Finish)	Back Set: 50x85			MLB92PCS	-	-
Lock Body (Black PVD Finish)	Back Set: 50x85			MLB92PBS	-	-
Lock Body (Antique Finish)	Back Set: 50x85			MLB92ATS	-	-
Lock Body (S.S. Finish)	Back Set: 60x85			MLB94S	-	-
Lock Body (Gold PVD Finish)	Back Set: 60x85			MLB94PGS	-	-
Lock Body (Copper PVD Finish)	Back Set: 60x85			MLB94PCS	-	-
Lock Body (Black PVD Finish)	Back Set: 60x85			MLB94PBS	-	-
Lock Body (Antique Finish)	Back Set: 60x85			MLB94ATS	-	-
Mortise Lock Body	Back Set: 50x50		MLB72S	-	-	
Dead Bolt	Back Set: 50		MDBS	-	-	
Dead Bolt (Brass Dead Bolt)	Back Set: 50	 	MDB1S	-	-	
Mortise Latch	Back Set: 50		ML2S	-	-	
Lock Body (3 Bolt)	Back Set: 50x85		MLB39S	-	-	
Lock Body (4 Bolt Wide Body) (S.S. Finish) Back Set: 60x85				MLB49S	-	-
Lock Body (4 Bolt Wide Body) (Gold PVD Finish) Back Set: 60x85				MLB49PGS	-	-
Lock Body (4 Bolt Wide Body) (Copper PVD Finish) Back Set: 60x85				MLB49PCS	-	-
Lock Body (4 Bolt Wide Body) (Antique Finish) Back Set: 60x85				MLB49ATS	-	-

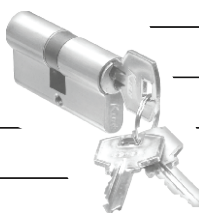
MORTICE LOCK BODY

Description	Size	Product	Code	Price per piece		
				Glossy	Satin	Combi.
Double Door Lock Body	Back Set: 45x85		MLBD1RS	-		-
			MLBD1LS	-		-
Narrow Lock Body	Back Set: 25x85		MLBN1S	-		-
Narrow Dead Bolt	Back Set: 25		MDBNS	-		-
Sliding Door Lock Body	Back Set: 40		MDB6S	-		-
Roller Bolts Lock Body	Back Set: 45		MLB69S	-		-
Mortice Lock (Regular Body)	Back Set: 50x85		MLB59S	-		-
Mortice Lock (Wide Body)	Back Set: 60x85		MLB529S	-		-
Dead Bolt	Back Set: 55		MDB5S	-		-
Latch Bolt	Back Set: 55		ML5S	-		-
Mortice Lock (to Fix with Thumb Turn only)	Back Set: 55x78		MLB5TTS	-		-









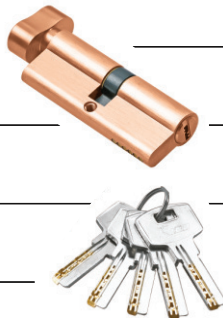

MORTICE PIN CYLINDERS - SECURE STANDARD (STANDARD KEY)

Pin Cylinder (Both side Key)	60mm		PCBSKS60	-		-
Pin Cylinder (Key & Knob)	60mm		PCKNS60	-		-
Pin Cylinder (Slot & Knob)	60mm		PCSNS60	-		-
Half Cylinder (One side Key)	60mm (40mm)		PCHKS60	-		-
Half Cylinder (One side Knob)	60mm (40mm)		PCHNS60	-		-
Pin Cylinder (Both side Key)	70mm		PCBSKS70	-		-
Pin Cylinder (Key & Knob)	70mm		PCKNS70	-		-
Pin Cylinder (Slot & Knob)	70mm		PCSNS70	-		-
Pin Cylinder (Slot & Knob) Gold PVD Finish	70mm		PCSNS70PGS	-		-
Pin Cylinder (Slot & Knob) Copper PVD Finish	70mm		PCSNS70PCS	-		-
Pin Cylinder (Slot & Knob) Zirconium PVD Finish	70mm		PCSNS70PZS	-		-
Pin Cylinder (Slot & Knob) Black PVD Finish	70mm		PCSNS70PBS	-		-
Pin Cylinder (Slot & Knob) Antique Finish	70mm		PCSNS70ATS	-		-
Half Cylinder (One side Key)	70mm (45mm)		PCHKS70	-		-
Half Cylinder (One side Knob)	70mm (45mm)		PCHNS70	-		-

MORTICE PIN CYLINDERS - SECURE STANDARD (STANDARD KEY)

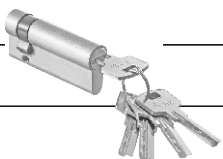
Description	Size	Product	Code	Price per piece		
				Glossy	Satin	Combi.
Half Cylinder (One side Knob) Gold PVD Finish	70mm (45mm)		PCHNS70PGS	-		-
Half Cylinder (One side Knob) Copper PVD Finish	70mm (45mm)		PCHNS70PCS	-		-
Half Cylinder (One side Knob) Zirconium PVD Finish	70mm (45mm)		PCHNS70PZS	-		-
Half Cylinder (One side Knob) Black PVD Finish	70mm (45mm)		PCHNS70PBS	-		-
Half Cylinder (One side Knob) Antique Finish	70mm (45mm)		PCHNS70ATS	-		-
Pin Cylinder (Both side Key)	80mm		PCBSKS80	-		-
Pin Cylinder (Key & Knob)	80mm		PCKNS80	-		-
Pin Cylinder (Slot & Knob)	80mm		PCSNS80	-		-
Pin Cylinder (Slot & Knob) Gold PVD Finish	80mm		PCSNS80PGS	-		-
Pin Cylinder (Slot & Knob) Copper PVD Finish	80mm		PCSNS80PCS	-		-
Pin Cylinder (Slot & Knob) Zirconium PVD Finish	80mm		PCSNS80PZS	-		-
Pin Cylinder (Slot & Knob) Black PVD Finish	80mm		PCSNS80PBS	-		-
Pin Cylinder (Slot & Knob) Antique PVD Finish	80mm		PCSNS80ATS	-		-
Half Cylinder (One side Key)	80mm (50mm)		PCHKS80	-		-
Half Cylinder (One side Knob)	80mm (50mm)		PCHNS80	-		-
Pin Cylinder (One Side Knob) Gold PVD Finish	80mm		PCHNS80PGS	-		-
Pin Cylinder (One Side Knob) Copper PVD Finish	80mm		PCHNS80PCS	-		-
Pin Cylinder (One Side Knob) Zirconium PVD Finish	80mm		PCHNS80PZS	-		-
Pin Cylinder (One Side Knob) Black PVD Finish	80mm		PCHNS80PBS	-		-
Pin Cylinder (One Side Knob) Antique PVD Finish	80mm		PCHNS80ATS	-		-
Pin Cylinder (Both side Key)	90mm		PCBSKS90	-		-
Pin Cylinder (Key & Knob)	90mm		PCKNS90	-		-
Pin Cylinder (Slot & Knob)	90mm		PCSNS90	-		-
Pin Cylinder (Both side Key)	100mm		PCBSKS100	-		-
Pin Cylinder (Key & Knob)	100mm		PCKNS100	-		-
Pin Cylinder (Slot & Knob)	100mm		PCSNS100	-		-
Master Key for up to 10 Cylinders (Per Cylinder)			-	-		-
Master Key for up to 25 Cylinders (Per Cylinder)			-	-		-

MORTICE PIN CYLINDERS - SECURE PLUS (COMPUTERIZED DOTTED KEY)

Description	Size	Product	Code	Price per piece		
				Glossy	Satin	Combi.
Pin Cylinder (Both Side Key)	60mm		PC11KK60	-		-
Pin Cylinder (Key & Knob)	60mm		PC11KN60	-		-
Pin Cylinder (Both side Key)	70mm		PC11KK70	-		-
Pin Cylinder (Key & Knob)	70mm		PC11KN70	-		-
Pin Cylinder (Key & Knob) Gold PVD Finish	70mm 		PC11KN70PGS	-		-
Pin Cylinder (Key & Knob) Copper PVD Finish	70mm 		PC11KN70PCS	-		-
Pin Cylinder (Key & Knob) Zirconium PVD Finish	70mm 		PC11KN70PZS	-		-
Pin Cylinder (Key & Knob) Black PVD Finish	70mm 		PC11KN70PBS	-		-
Pin Cylinder (Key & Knob) Antique Finish	70mm 		PC11KN70ATS	-		-
Pin Cylinder (Both side Key)	80mm		PC11KK80	-		-
Pin Cylinder (Key & Knob)	80mm		PC11KN80	-		-
Pin Cylinder (Key & Knob) Gold PVD Finish	80mm 		PC11KN80PGS	-		-
Pin Cylinder (Key & Knob) Copper PVD Finish	80mm 		PC11KN80PCS	-		-
Pin Cylinder (Key & Knob) Zirconium PVD Finish	80mm 		PC11KN80PZS	-		-
Pin Cylinder (Key & Knob) Black PVD Finish	80mm 		PC11KN80PBS	-		-
Pin Cylinder (Key & Knob) Antique PVD Finish	80mm 		PC11KN80ATS	-		-
Pin Cylinder (Key & Knob)	90mm		PC11KN90	-		-

Mechanical warranty is not applicable on Master Key Cylinders

NIGHT LATCH (IN BRASS)

Night Latch Key & Knob Standard key		NLKN11S	-		-
Night Latch Key & Knob (Double Bolts) Standard Key		NLKN12S	-		-
Night Latch Key & Knob Computerised Dotted Key		NLKN21S	-		-
Night Latch Key & Knob Computerised Dotted Key	 	NLKN31S	-		-



STAINLESS STEEL AISI 316 GRADE DOOR & WINDOW HINGES



Description	Product	Size (mm)	Code	Price	
		(L x W x T)		Per Piece	
Door Hinge W/O Bearing		76X67X2	DH123S		
Door Hinge W/O Bearing		100X62X2	DH124S		
Door Hinge W/O Bearing		125X62X2	DH125S		
Door Hinge W/O Bearing		76X78X3	DH133S		
Door Hinge W/O Bearing		102X76X3	DH134S		
Door Hinge with 4 Bearing		102X76X3	DH234S		
Door Hinge W/O Bearing		125X75X3	DH135S		
Door Hinge with 4 Bearing		125X75X3	DH235S		
Door Hinge W/O Bearing		152x78x3	DH136S		
Door Hinge with 4 Bearing		152x78x3	DH236S		
Window Hinge W/O Bearing			76x45x1.5	WH13S	
Window Hinge W/O Bearing			102x45x1.5	WH14S	
Door Hinge with 2 Bearing		102x76x3	PRDHT2-102x76x3		
Sintered Bush Bearing Hinge Radius Corner		100x88x3	DH51RS		
Sintered Bush Bearing Hinge Square Corner		100x88x3	DH51SS		
Concealed Bearing Hinge Radius Corner		102x76x3	DH71RS		
Concealed Bearing Hinge Square Corner		102x76x3	DH71SS		

■ All Prices Include S.S Self Tapping Philips Cross Head Special Screw. ■ DH1 : Without Bearings ■ DH2 : With Bearings ■ PRDHT2 Includes SS Screw

STAINLESS STEEL AISI 304 GRADE DOOR & WINDOW HINGES

Door Hinges with 4 Bearing		150x75x3	PRBHB36S	
Door Hinges with 4 Bearing		125x75x3	PRBHB35S	
Door Hinges with 4 Bearing		102x76x3	PRBHB34S	
Door Hinges with 2 Bearing		125x75x3	PRBH2B35S	
Door Hinges with 2 Bearing		102x76x3	PRBH2B34S	
Door Hinges W/O Bearing		125x75x3	PRBH35S	
Door Hinges W/O Bearing		100x75x3	PRBH34S	
Door Hinges W/O Bearing		125x62x2	PRBH25S	
Door Hinges W/O Bearing		100x62x2	PRBH24S	
Door Hinges W/O Bearing		75x62x2	PRBH23S	
S.S. Screws - 8x25mm (For 100 Pcs)		-	-	
S.S. Screws - 8x32mm (For 100 Pcs)		-	-	

STAINLESS STEEL AISI 316 GRADE PULL HANDLES ('84', '85', '86') (FOR WOODEN & GLASS DOORS)

Description	Size	Product	Code	Price per set		
				Glossy	Satin	Combi.
Pull Handle '85'	40mmx10mmx300mmx400mm		PHH854012S	-		-
Pull Handle '85'	40mmx10mmx450mmx550mm		PHH854018S	-		-
Pull Handle '85'	40mmx10mmx600mmx700mm		PHH854024S	-		-
Pull Handle '86'	40mmx20mmx300mmx400mm		PHH864012S	-		-
Pull Handle '86'	40mmx20mmx450mmx550mm		PHH864018S	-		-
Pull Handle '86'	40mmx20mmx600mmx700mm		PHH864024S	-		-

STAINLESS STEEL AISI 316 GRADE PULL HANDLES ('82') (FOR WOODEN & GLASS DOORS)

Pull Handle '82'	19 mm x 200 mm		PH821908S	-		-
Pull Handle '82'	19 mm x 250 mm		PH821910S	-		-
Pull Handle '82'	19 mm x 300 mm		PH821912S	-		-
Pull Handle '82'	25 mm x 300 mm		PH822512S	-		-
Pull Handle '82'	25 mm x 450 mm		PH822518S	-		-
Pull Handle '82'	25 mm x 600 mm		PH822524S	-		-

STAINLESS STEEL AISI 316 GRADE PULL HANDLES (SOLID RECTANGLE - 'N') (FOR WOODEN & GLASS DOORS)

Pull Handle 'N'	22 x 8 mm x 200 mm		PHN2208S	-		-
Pull Handle 'N'	22 x 8 mm x 250 mm		PHN2210S	-		-
Pull Handle 'N'	22 x 8 mm x 300 mm		PHN2212S	-		-

STAINLESS STEEL AISI 316 GRADE PULL HANDLES (FLAT) (FOR WOODEN & GLASS DOORS)

Pull Handle	Ø 22 mm x 200 mm		PH2208FS	-		-
Pull Handle	Ø 22 mm x 250 mm		PH2210FS	-		-
Pull Handle	Ø 22 mm x 300 mm		PH2212FS	-		-

STAINLESS STEEL AISI 316 GRADE PULL HANDLES ('C' SHAPE) (FOR WOODEN & GLASS DOORS)

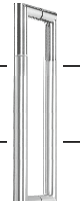
Pull Handle 'C'	Ø 22 mm x 200 mm		PHC2208	-		-
Pull Handle 'C'	Ø 22 mm x 250 mm		PHC2210	-		-
Pull Handle 'C'	Ø 22 mm x 300 mm		PHC2212	-		-

STAINLESS STEEL AISI 316 GRADE PULL HANDLES ('C' SHAPE) (FOR WOODEN & GLASS DOORS)

Description	Size	Product	Code	Price per set		
				Glossy	Satin	Combi.
Pull Handle 'C'	Ø 25 mm x 250 mm		PHC2510	-	-	-
Pull Handle 'C'	Ø 25 mm x 300 mm		PHC2512	-	-	-
Pull Handle 'C'	Ø 25 mm x 350 mm		PHC2514	-	-	-
Pull Handle 'C'	Ø 25 mm x 450 mm		PHC2518	-	-	-
Pull Handle 'C'	Ø 25 mm x 600 mm		PHC2524	-	-	-
Pull Handle 'C'	Ø 32 mm x 450 mm		PHC3218	-	-	-
Pull Handle 'C'	Ø 32 mm x 600 mm		PHC3224	-	-	-
Pull Handle 'C'	Ø 32 mm x 900 mm		PHC3236	-	-	-
Pull Handle 'C'	Ø 38 mm x 600 mm		PHC3824	-	-	-
Pull Handle 'C'	Ø 38 mm x 900 mm		PHC3836	-	-	-
Pull Handle 'C'	Ø 38 mm x 1200 mm		PHC3848	-	-	-

STAINLESS STEEL AISI 316 GRADE PULL HANDLES (FOR WOODEN & GLASS DOORS)

Pull Handle	Ø 19 mm x 150 mm		PH1906	-	-	-
Pull Handle	Ø 19 mm x 200 mm		PH1908	-	-	-
Pull Handle	Ø 19 mm x 250 mm		PH1910	-	-	-
Pull Handle	Ø 19 mm x 300 mm		PH1912	-	-	-
Pull Handle	Ø 22 mm x 200 mm		PH2208	-	-	-
Pull Handle	Ø 22 mm x 250 mm		PH2210	-	-	-
Pull Handle	Ø 22 mm x 300 mm		PH2212	-	-	-
Pull Handle	Ø 25 mm x 300 mm		PH2512	-	-	-
Pull Handle	Ø 25 mm x 450 mm		PH2518	-	-	-
Pull Handle	Ø 25 mm x 600 mm		PH2524	-	-	-
Pull Handle	Ø 32 mm x 600 mm		PH3224	-	-	-
Pull Handle	Ø 32 mm x 900 mm		PH3236	-	-	-
Pull Handle	Ø 38 mm x 900 mm		PH3836	-	-	-

STAINLESS STEEL AISI 316 GRADE PULL HANDLES ('H' SHAPE - Form Drill) (FOR WOODEN & GLASS DOORS)

Pull Handle 'H'	Ø 22 mm x 200mm x 300 mm		PHH2208S	-	-	-
Pull Handle 'H'	Ø 22 mm x 300mm x 400 mm		PHH2212S	-	-	-
Pull Handle 'H'	Ø 25 mm x 250mm x 350 mm		PHH2510S	-	-	-
Pull Handle 'H'	Ø 25 mm x 350mm x 450 mm		PHH2514S	-	-	-
Pull Handle 'H'	Ø 25 mm x 500mm x 600 mm		PHH2520S	-	-	-
Pull Handle 'H'	Ø 32 mm x 350mm x 450 mm		PHH3214S	-	-	-
Pull Handle 'H'	Ø 32 mm x 500mm x 600 mm		PHH3220S	-	-	-
Pull Handle 'H'	Ø 32 mm x 650mm x 750 mm		PHH3226S	-	-	-
Pull Handle 'H'	Ø 32 mm x 800mm x 900 mm		PHH3232S	-	-	-
Pull Handle 'H'	Ø 38 mm x 750mm x 900 mm		PHH3830S	-	-	-
Pull Handle 'H'	Ø 38 mm x 1050mm x 1200 mm		PHH3842S	-	-	-
Pull Handle 'H'	Ø 38 mm x 1350mm x 1500 mm		PHH3854S	-	-	-

STAINLESS STEEL AISI 316 GRADE GRAB RAILS

Description	Size	Product	Code	Price per set		
				Glossy	Satin	Combi.
Grab Rail	Ø 22 mm x 200 mm		GR2208	-	-	-
Grab Rail	Ø 22 mm x 250 mm		GR2210	-	-	-
Grab Rail	Ø 22 mm x 300 mm		GR2212	-	-	-
Grab Rail	Ø 25 mm x 300 mm		GR2512	-	-	-

STAINLESS STEEL AISI 316 GRADE PULL HANDLES (SQUARE) (FOR WOODEN & GLASS DOORS)

Pull Handle 'S'	Ø 22 mm x 300 mm		PHS2212	-	-	-
Pull Handle 'S'	Ø 25 mm x 300 mm		PHS2512	-	-	-

STAINLESS STEEL AISI 316 GRADE PULL HANDLES ('J' SHAPE) (FOR WOODEN & GLASS DOORS)

Pull Handle 'J'	Ø 25 mm x 300 mm		PHJ2512S	-	-	-
Pull Handle 'J'	Ø 25 mm x 350 mm		PHJ2514S	-	-	-

STAINLESS STEEL AISI 316 GRADE PULL HANDLES ('G' SHAPE) (FOR WOODEN & GLASS DOORS)

Pull Handle 'G'	Ø 22 mm x 300 mm		PHG2212S	-	-	-
Pull Handle 'G'	Ø 25 mm x 300 mm		PHG2512S	-	-	-

STAINLESS STEEL AISI 316 GRADE PULL HANDLE ON PLATE









Pull Handle on Plate Pull Handle Ø19mm x 200mm Plate 300mm x 75mm		PH1908S + PS300 x 75S	-	-	-
---	---	--------------------------	---	---	---

STAINLESS STEEL AISI 316 GRADE PULL HANDLE WITH LOCK

Pull Handle with Lock Ø 38mm x 1125mm (C/C) x 1500mm (L) (Include Floor Dust Socket)		PL38x1125CTC x1500mm	-	-	-
--	---	-------------------------	---	---	---





DOOR CLOSERS

Description	Size	Product	Code	Price per piece		
				Glossy	Satin	Combi.
Door Closer (Over Head - Up to 60 Kg) - Silver			DC510S	-		-
Door Closer (Over Head - Up to 60 Kg) - Gold			DC510GS	-		-
Door Closer (Over Head - Up to 80 Kg) - Silver			DC511S	-		-
Door Closer (Over Head - Up to 80 Kg) - Gold			DC511GS	-		-
Door Closer (Over Head - Up to 90 Kg) - Silver			DC512S	-		-
Door Closer (Over Head - Up to 90 Kg) - Gold			DC512GS	-		-
Door Closer (Over Head - Up to 90 Kg) - Black			DC512BS	-		-
Door Closer (Over Head - Up to 90 Kg) - Antique			DC512ATS	-		-
Door Closer (Over Head - Up to 90 Kg) Stainless Steel			DC512SS	-		-
Door Closer (Over Head - Hold Open - Up to 90 Kg) - Silver			DC522S	-		-
Door Closer (Over Head - Hold Open - Up to 90 Kg) - Gold			DC522GS	-		-
Door Closer (Over Head - Hold Open - Up to 90 Kg) - Black			DC522BS	-		-
Door Closer (Over Head - Hold Open - Up to 90 Kg) - Antique			DC522ATS	-		-
Door Closer (Over Head - Hold Open - Up to 90 Kg) - Stainless Steel			DC522SS	-		-
Door Closer (Concealed - Up to 90 KG) - Silver			DCC611S	-		-



BALL BEARING DRAWER SLIDES

Description	Size	Product	Code	Price per Pair		
				Glossy	Satin	Combi.
Drawer Slides	10"		DS5110S	-		-
Drawer Slides	12"		DS5112S	-		-
Drawer Slides	14"		DS5114S	-		-
Drawer Slides	16"		DS5116S	-		-
Drawer Slides	18"		DS5118S	-		-
Drawer Slides	20"		DS5120S	-		-
Drawer Slides	22"		DS5122S	-		-
Drawer Slides	24"		DS5124S	-		-
Drawer Slide - Black	10"		DS5110B	-		-
Drawer Slide - Black	12"		DS5112B	-		-
Drawer Slide - Black	14"		DS5114B	-		-
Drawer Slide - Black	16"		DS5116B	-		-
Drawer Slide - Black	18"		DS5118B	-		-
Drawer Slide - Black	20"		DS5120B	-		-
Drawer Slide - Black	22"		DS5122B	-		-
Drawer Slide - Black	24"		DS5124B	-		-

SLIDE ON HINGE

Description	Size	Product	Code	Price per Pair		
				Glossy	Satin	Combi.
		Full Overlay	CP 101	-		-
		Half Overlay	CP 102	-		-
		Inset	CP 103	-		-

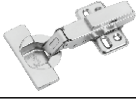
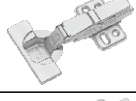

SOFT-CLOSING CLIP ON HINGE

		Full Overlay	CP 301	-		-
		Half Overlay	CP 302	-		-
		Inset	CP 303	-		-



STAINLESS STEEL AISI 316 GRADE WINDOW CASEMENT STAY (STOPPER)

Description	Size	Product	Code	Price per piece		
				Glossy	Satin	Combi.
Window Casement Stay	250mm		WCS12250	-		-

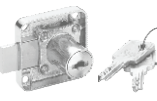







DRAWER LOCKS

Drawer Lock Standard Key		DI111	-		-
Drawer Lock Standard Key (For Glass)		DLG511	-		-
Drawer Lock Computerise Dotted Key		DL311	-		-





STAINLESS STEEL AISI 304 GRADE CUPBOARD LOCKS & DRAWER LOCKS

Drawer Lock - 20mm		DI611	-		-
Cupboard Lock - 25mm		DI712	-		-
Cupboard Lock - 30mm		DI713	-		-

STAINLESS STEEL AISI 316 GRADE CABINET HANDLES

Product	Size	Shape	Code	Price per piece		
				Glossy	Satin	Combi.
	□ 3mm x 96mm	A-3	CHA34S	-	-	-
	□ 3mm x 128mm	A-3	CHA35S	-	-	-
	□ 3mm x 160mm	A-3	CHA36S	-	-	-
	□ 8mm x 96mm	A-5	CHA54	-	-	-
	□ 8mm x 128mm	A-5	CHA55	-	-	-
	□ 8mm x 160mm	A-5	CHA56	-	-	-
	□ 8mm x 96mm	A-6	CHA64	-	-	-
	□ 8mm x 128mm	A-6	CHA65	-	-	-
	□ 8mm x 160mm	A-6	CHA66	-	-	-
	□ 8mm x 96mm	A-7	CHA74	-	-	-
	□ 8mm x 128mm	A-7	CHA75	-	-	-
	□ 8mm x 160mm	A-7	CHA76	-	-	-
	□ 8mm x 224mm	A-7	CHA78	-	-	-
	□ 8mm x 96mm	A-8	CHA84	-	-	-
	□ 8mm x 128mm	A-8	CHA85	-	-	-
	□ 8mm x 160mm	A-8	CHA86	-	-	-
	□ 8mm x 96mm	A-9	CHA94	-	-	-
	□ 8mm x 128mm	A-9	CHA95	-	-	-
	□ 8mm x 160mm	A-9	CHA96	-	-	-
	Ø 10 mm x 96 mm	C	CHC104	-	-	-
	Ø 10 mm x 128 mm	C	CHC105	-	-	-
	Ø 10 mm x 160 mm	C	CHC106	-	-	-
	Ø 10 mm x 96 mm	F	CHF104	-	-	-
	Ø 10 mm x 128 mm	F	CHF105	-	-	-
	Ø 10 mm x 160 mm	F	CHF106	-	-	-
	Ø 10 mm x 64 mm	H	CHH103	-	-	-
	Ø 10 mm x 96 mm	H	CHH104	-	-	-
	Ø 10 mm x 128 mm	H	CHH105	-	-	-
	Ø 10 mm x 160 mm	H	CHH106	-	-	-
	Ø 10 mm x 224 mm	H	CHH108	-	-	-
	Ø 10 mm x 288 mm	H	CHH1010	-	-	-
	Ø 10 mm x 352 mm	H	CHH1012	-	-	-

STAINLESS STEEL AISI 316 GRADE CABINET HANDLES

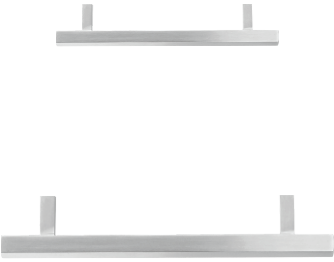
Product	Size	Shape	Code	Price per piece		
				Glossy	Satin	Combi.
	Ø 10 mm x 96 mm	I	CHI104	-		
	Ø 10 mm x 128 mm	I	CHI105	-		
	Ø 10 mm x 160 mm	I	CHI106	-		
	Ø 10 mm x 96 mm	L	CHL104	-		-
	Ø 10 mm x 128 mm	L	CHL105	-		-
	Ø 10 mm x 160 mm	L	CHL106	-		-
	Ø 8 mm x 64 mm	R	CHR83	-		
	Ø 8 mm x 96 mm	R	CHR84	-		
	Ø 8 mm x 128 mm	R	CHR85	-		
	Ø 8 mm x 160 mm	R	CHR86	-		
	Ø 10 mm x 64 mm	R	CHR103	-		
	Ø 10 mm x 96 mm	R	CHR104	-		
	Ø 10 mm x 128 mm	R	CHR105	-		
	Ø 10 mm x 160 mm	R	CHR106	-		
	Ø 10 mm x 224 mm	R	CHR108	-		
	Ø 10 mm x 288 mm	R	CHR1010	-		
	□ 10mm x 96mm	S	CHS104S	-		-
	□ 10mm x 128mm	S	CHS105S	-		-
	□ 10mm x 160mm	S	CHS106S	-		-
	□ 10mm x 224mm	S	CHS108S	-		-
	□ 10mm x 288mm	S	CHS1010S	-		-
	□ 10mm x 352mm	S	CHS1012S	-		-
	□ 12mm x 96mm	S	CHS124S	-		-
	□ 12mm x 128mm	S	CHS125S	-		-
□ 12mm x 160mm	S	CHS126S	-		-	

STAINLESS STEEL AISI 316 GRADE CONCEALED HANDLES

	70mm	Round	CH70S	-		-
	90mm	Round	CH90S	-		-
	55mm	Square	CH135S	-		-
	75mm	Square	CH136S	-		-
	100mm	Rectangle	CH100S	-		-
	150mm	Rectangle	CH101S	-		-
	120mm	Oval	CH120S	-		-
	150mm	Oval	CH121S	-		-
	120mm	Spl. Oval	CH125S	-		-

STAINLESS STEEL AISI 316 GRADE D R A W E R K N O B S

Product	Code	SMALL SIZE		
		Price per piece		
		Glossy	Satin	Combi.
	N11	-	153.00	-
	N31	-	131.00	-
	N211	-	168.00	-
	N56	-	146.00	-
	N58	-	145.00	-

Product	Code	BIG SIZE		
		Price per piece		
		Glossy	Satin	Combi.
	N12	-		-
	N32	-		-
	N212	-		-
	N59	-		-

DOOR STOPPER

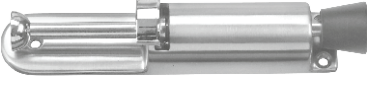
Description	Product	Code	Price per piece		
			Glossy	Satin	Combi.
Door stopper (Zinc)		DSTRS	-		-



STAINLESS STEEL AISI 316 GRADE D O O R S T O P S

Door stop		DST75S	-		-
Door stop		DST100S	-		-
Door stop floor dome		DSTFD	-		-
Door stop floor flat		DSTFF	-		-
Door stop half moon		DSTHMS	-		-
Door stop		DSTHMS2	-		-

DOOR VIEWER (IN BRASS)

Door Viewer (with Flap)		DV12S	-		-
-------------------------	---	-------	---	--	---

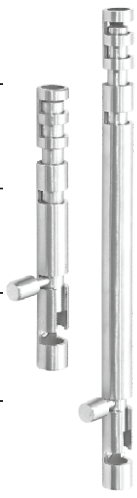



STAINLESS STEEL AISI 304 GRADE TOWER BOLTS

Description	Product	Code	Price per piece		
			Glossy	Satin	Combi.
Tower Bolt - Square 75mm		TBS33S	-		-
Tower Bolt - Square 100mm		TBS34S	-		-
Tower Bolt - Square 150mm		TBS36S	-		-
Tower Bolt - Square 200mm		TBS38S	-		-
Tower Bolt - Square 250mm		TBS310S	-		-
Tower Bolt - Square 300mm		TBS312S	-		-
Tower Bolt - Round 100mm		TBR34S	-		-
Tower Bolt - Round 150mm		TBR36S	-		-
Tower Bolt - Round 200mm		TBR38S	-		-
Tower Bolt - Round 250mm		TBR310S	-		-
Tower Bolt - Round 300mm		TBR312S	-		-
Tower Bolt - Flat 100mm		<i>New</i> TBF34S	-		-
Tower Bolt - Flat 150mm		TBF36S	-		-
Tower Bolt - Flat 200mm		TBF38S	-		-
Tower Bolt - Flat 250mm		TBF310S	-		-
Tower Bolt - Flat 300mm		TBF312S	-		-



DIGITAL SAFES *New*

Description	Product	Code	Price per piece		
			Glossy	Satin	Combi.
Digital Safe (WxHxD) (350x215x200) Volume: Up to 13 Ltr.		SD1131B	-		-
Digital Safe (WxHxD) (350x250x250) Volume: Up to 21 Ltr.		SD1132B	-		-
Digital Safe (WxHxD) (450x350x350) Volume: Up to 54 Ltr.		SD1133B	-		-
Digital Safe (WxHxD) (430x215x380) (Laptop Size) Volume: Up to 34 Ltr.		SD1134B	-		-
Digital Safe (WxHxD) (350x215x200) Volume: Up to 13 Ltr.		SD1231B	-		-
Digital Safe (WxHxD) (350x250x250) Volume: Up to 21 Ltr.		SD1232B	-		-
Digital Safe (WxHxD) (450x350x350) Volume: Up to 54 Ltr.		SD1233B	-		-
Digital Safe (WxHxD) (430x215x380) (Laptop Size) Volume: Up to 34 Ltr.		SD1234B	-		-

FLOOR SPRINGS











Description	Size	Product	Code	Price per piece		
				Glossy	Satin	Combi.
Weight Capacity upto 80 Kg. (Single Cylinder)			FS111S	-		-
Weight Capacity upto 100 Kg. (Double Cylinder)			FS112S	-		-
Weight Capacity upto 120 Kg. (Double Cylinder)		 	FS113S	-		-

PR SERIES FLOOR SPRINGS

Weight Capacity up to 80 Kg. (Singl Cylinder)			PRFS222S	-		-
Weight Capacity up to 100 Kg. (Double Cylinder)			PRFS223S	-		-







Note: All Floor Springs are with S.S. 304 cover

PATCH FITTINGS







Top Patch			PF11S	-		-
Bottom Patch			PF12S	-		-
Patch - Over Panel			PF13S	-		-
Patch Lock			PF14S PC11KK60	-		-
Patch - L			PF15S	-		-
Patch - Corner			PF16S	-		-
Patch - Connector			PF17S	-		-
Patch - Four way			PF18S	-		-
Pivot - Top For Glass Doors			PFP1S	-		-
Pivot - Set for Wooden Door & Aluminum Door			PFP2S	-		-

Note: All Patch Fittings are with S.S. 304 cover & high quality aluminum body







STAINLESS STEEL AISI 304 GRADE SHOWER HINGES

Description	Size	Product	Code	Price per piece		
				Glossy	Satin	Combi.
Wall to Glass-90 Degree			SH111S	-		-
Glass to Glass 90 Degree			SH112S	-		-
Glass to Glass 135 Degree			SH113S	-		-
Glass to Glass 180 Degree			SH114S	-		-
Wall to Glass Fix			SH115S	-		-
Wall to Glass-90 Degree (offset)			SH116S	-		-





SHOWER HINGES (IN BRASS)

Wall to Glass - 90 Degree			SH511G		-	-
Glass to Glass - 90 Degree			SH512G		-	-
Glass to Glass - 135 Degree			SH513G		-	-
Glass to Glass - 180 Degree			SH514G		-	-
Wall to Glass Fix			SH515G		-	-
Wall to Glass - 90 Degree (offset)			SH516G		-	-







STAINLESS STEEL AISI 304 GRADE GLASS CONNECTORS

Description	Size	Product	Code	Price per piece		
				Glossy	Satin	Combi.
Glass Connector (Fix)			GC11S			-
Glass Connector Wall to Glass-90 Degree			GC12S			-
Glass Connector Glass to Glass-90 Degree			GC13S			-
Glass Connector Glass to Glass-135 Degree			GC14S			-
Glass Connector Glass to Glass-180 Degree			GC15S			-
Glass Connector Wall to Glass-180 Degree			GC16S			-



SHOWER CUBIC ACCESSORIES (IN BRASS)

Shower Bracket (Wall)			SB11G		-	-
Shower Bracket (End Bracket)			SB12G		-	-
Shower Bracket (Support Bracket)			SB13G		-	-
Shower Bracket (Two Way)			SB14G		-	-
Shower Bracket (Three Way)			SB15G		-	-



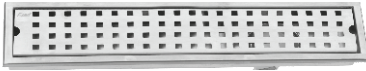

GLASS DOOR PLASTIC PROFILE (2.2 METERS)

Description	Size	Product	Code	Price per piece
G2G 90 Degree for 10mm. Glass			SPP1110	
G2G 180 Degree for 10mm. Glass			SPP1310	
G2W for 10mm. Glass			SPP2110	
G2W for 10mm. Glass			SPP3110	
G2G 90 Degree Magnetic for 10mm. Glass			SPM1110	
G2G 135 Degree Magnetic for 10mm. Glass			SPM1210	
G2G 180 Degree Magnetic for 10mm. Glass			SPM1310	











STAINLESS STEEL AISI 304 GRADE S H O W E R D R A I N S

Product	Description	Code	Price per piece		
			Glossy	Satin	Black Satin
	Shower Floor Drain 100x300mm	FDS1112	-		-
	Shower Floor Drain 100x450mm	FDS1118	-		-
	Shower Floor Drain 100x600mm	FDS1124	-		-
	Shower Floor Drain 100x900mm	FDS1136	-		-
	Shower Floor Drain 100x300mm	FDS1212	-		-
	Shower Floor Drain 100x450mm	FDS1218	-		-
	Shower Floor Drain 100x600mm	FDS1224	-		-
	Shower Floor Drain 100x900mm	FDS1236	-		-
	Shower Floor Drain 100x300mm	FDS1312	-		-
	Shower Floor Drain 100x450mm	FDS1318	-		-
	Shower Floor Drain 100x600mm	FDS1324	-		-
	Shower Floor Drain 100x900mm	FDS1336	-		-
	Tile Insert Shower Floor Drain 100x300mm	SFD1412	-		-
	Tile Insert Shower Floor Drain 100x450mm	SFD1418	-		-
	Tile Insert Shower Floor Drain 100x600mm	SFD1424	-		-
	Tile Insert Shower Floor Drain 100x900mm	SFD1436	-		-









STAINLESS STEEL AISI 304 GRADE F L O O L D R A I N S

	Tile Insert Floor Drain 127x127mm	FD255	-		-
	Tile Insert Floor Drain 150x150mm	FD256	-		-
	Auto Close Floor Drain 127x127mm	FD245	-		
	Auto Close Floor Drain 150x150mm	FD246	-		
	Auto Close Floor Drain 127x127mm	FD215	-		
	Auto Close Floor Drain 150x150mm	FD216	-		
	Auto Close Floor Drain 127x127mm	FD235	-		
	Auto Close Floor Drain 150x150mm	FD236	-		











STAINLESS STEEL AISI 304 GRADE FLOOR DRAINS

Product	Description	Code	Price per piece		
			Glossy	Satin	Black Satin
	Auto Close Floor Drain 127x127mm	FD225	-		
	Auto Close Floor Drain 150x150mm	FD226	-		
	Insect Repeller Floor Drain 127x127mm	FD365	-		
	Insect Repeller Floor Drain 150x150mm	FD366	-		
	Standard Floor Drain 127x127mm	FD145	-		
	Standard Floor Drain 150x150mm	FD146	-		
	Standard Floor Drain 150x150mm	FD116	-		
	Standard Floor Drain 127x127mm	FD135	-		
	Standard Floor Drain 150x150mm	FD136	-		
	Standard Floor Drain 127x127mm	FD125	-		
	Standard Floor Drain 150x150mm	FD126	-		
	Standard Floor Drain 127x127mm	FD375	-		
	Standard Floor Drain 150x150mm	FD376	-		
	Wash Basin Floor Drain 127x127mm	FD145W	-		
	Wash Basin Floor Drain 150x150mm	FD146W	-		
	Wash Basin Floor Drain 127x127mm	FD135W	-		
	Wash Basin Floor Drain 150x150mm	FD136W	-		
	Wash Basin Floor Drain 127x127mm	FD125W	-		
	Wash Basin Floor Drain 150x150mm	FD126W	-		













STAINLESS STEEL AISI 316 GRADE BATHROOM ACCESSORIES (BA1)

Product	Description	Code	Price per piece		
			Glossy	Satin	Combi.
	Towel Rack 450	TTRC45			-
	Towel Rack 650	TTRC65			-
	Towel Rod 300	TTR30			-
	Towel Rod 450	TTR45			-
	Towel Rod 650	TTR65			-
	Napkin Ring - Round	TNR15			-
	Napkin Ring - Square	TNR16			-
	Round Liquid Soap Dispenser 150ml.	TLSD1S	-		-
	Round Liquid Soap Dispenser 250ml.	TLSD2S	-		-
	Round Liquid Soap Dispenser 150ml. Wall Mounted	TLSD1WMS	-		-
	Round Liquid Soap Dispenser 250ml. Wall Mounted	TLSD2WMS	-		-
	Square Liquid Soap Dispenser 150ml. Wall Mounted	TLSD6WMS	-		-
	Square Liquid Soap Dispenser 200ml. Wall Mounted	TLSD7WMS	-		-
 	Foot Liquid Dispenser	FLD11S	-		-





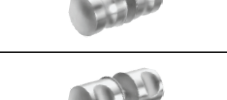





STAINLESS STEEL AISI 316 GRADE BATHROOM ACCESSORIES (BA1)

Product	Description	Code	Price per piece		
			Glossy	Satin	Combi.
	Shampoo shelf 300	TSS30			-
	Counter Soap Dish	TCSD			-
	Soap Dish 150	TSD15			-
	Soap Dish	TSD12			-
	Toilet Paper Roll Holder 155	TTPH			-
	Toilet Paper Roll Holder with Flap 155	TTPHF			-
	Toilet Paper Roll Holder	TTPH2			-
	Tooth Paste & Brush Holder	TPH			-
	Cloth liner	CL50			-
	Robe hook	RH50			-
	Robe hook	RH51			-
	5 Robe Hook on Plate	RHP5S	-		-
	3 Robe Hook on Plate	RHP3S	-		-





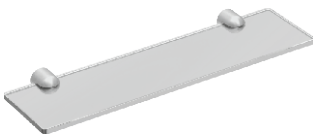

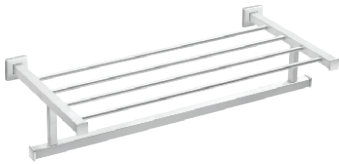

STAINLESS STEEL AISI 316 GRADE GLASS SHELF CORNER & THUMB TURN (BA1)

Product	Description	Code	Price per piece		
			Glossy	Satin	Combi.
	Glass Shelf - 150 mm	GSC115S	-		-
	Glass Shelf - 225 mm	GSC122S	-		-
	Thumb Turn (Round) Inner Rose: M.S.	TT525RS	-		-
	Indicator bolt	IB106	-		-
	Indicator bolt (Inner)	IB106I	-		-
	Ø 25 mm x 300+450 mm	PH2512+18			-
	Ø 25 mm x 400+600 mm	PH2516+24			-
	Shower Cubicle Handle with Knob	PH2518+DN81			-
	Shower Cubicle Handle with Knob	PH2518+DN82			-
	Shower Cubicle Handle with Knob	PH2518+DN83			-
	Door Knobs	DN81S	-		-
	Door Knobs	DN82S	-		-
	Door Knobs	DN83S	-		-
	Ø 25 mm x 300 mm	GB2512			-

STAINLESS STEEL AISI 316 GRADE BATHROOM ACCESSORIES (BA2)

Product	Description	Code	Price per piece		
			Glossy	Satin	Combi.
	Towel Rack 450	BA205		-	
	Towel Rack 650	BA206		-	
	Towel Rod - Single 300	BA215		-	
	Towel Rod - Single 450	BA216		-	
	Towel Rod - Single 650	BA217		-	
	Toilet Paper Roll Holder	BA220		-	
	Toilet Paper Roll Holder with Flap	BA221		-	
	Napkin Ring - Square	BA226		-	
	Soap Dish	BA230		-	
	Tooth Paste & Brush Holder	BA235		-	
	Brush Holder	BA250			-
	Glass Shelf 300	BA240			-
	Glass Shelf 450	BA241			-
	Robe Hook	BA245		-	

STAINLESS STEEL AISI 316 GRADE BATHROOM ACCESSORIES (BA3)

Product	Description	Code	Price per piece		
			Glossy	Satin	Combi.
	Towel Rack 450	BA305			-
	Towel Rack 650	BA306			-
	Towel Rod 450	BA316			-
	Towel Rod 650	BA317			-
	Toilet Paper Roll Holder	BA320			-
	Napkin Ring	BA326			-
	Soap Dish	BA330			-
	Soap Dish - Double	BA331			-
	Tooth Paste & Brush Holder	BA335			-
	Tooth Paste & Brush Holder-Double	BA336			-
	Robe-Hook	BA345			-