

FEBRUARY 2021



DRAWER SLIDES  
& HINGES



GENERAL  
HARDWARE



JOINERY  
FITTINGS &  
SCREWS



FURNITURE  
LOCKS



RETAIL  
DISPLAY  
SYSTEMS



WINDOW,  
DOOR & GLASS  
HARDWARE



HARDWARE SOLUTIONS

**OVER 50 YEARS  
OF CONTINUOUS INNOVATION.**



Ebco was founded in 1963 as a Tool Room and diversified into mass production of critical components such as Cartridge Links for Ordnance Factories. In 1987, Ebco diversified into furniture hardware and has since become India's leading manufacturer of intelligent home and office furniture fittings.

Today, Ebco's product range spans Office Furniture Fittings, Drawer Slides and Hinges, General Hardware, Joinery Fittings & Screws, Furniture Locks, Retail a Systems, Window-Door & Glass Hardware, Kitchen Systems & Accessories, Aluminium Profiles & Handles, Bed & Wardrobe Fittings & Accessories, Furniture Lights – LED. Our strengths include a range of core competencies in manufacturing, an ever-widening product range, stringent quality standards, affordable prices and an all-India distribution network.



Palghar Factory



Plant 1 - Vasai



Plant 3 - Palghar

## INFRASTRUCTURE

We have a state of the art design and product development department which uses the latest 3D design software and CNC Machining Technology. This enables us to launch many new products every month. Our Tool Room capacities have increased significantly which has reduced product development lead time. Our corporate office is located in India's financial capital, Mumbai; we have three manufacturing plants and multiple warehousing facilities north of Mumbai in the towns of Vasai and Palghar, Maharashtra.

Our plants use state-of-the-art roll forming and sheet metal pressing technology. Our products are engineered to perform and our quality department helps ensure that we consistently achieve this goal. Our Quality Assurance Laboratory at the Vasai manufacturing plant performs rigorous cycle tests, load tests and other checks in accordance with certified international quality norms. Our Window Fittings Plant in Palghar has been expanded to increase production capacity and we have commissioned two new warehouses in Palghar which have significantly increased our storage capacity.



Roll Forming Production Line



Design & Development Dept



Press Shop - Unit 2

## PRODUCT RANGE

Our products are organised in to 11 verticals under 3 brands, each of which are unique, comprehensive and satisfy a variety of requirements.

### **WORKSMART – ERGONOMIC HARDWARE FOR OFFICES**

Already a market leader in this category, we continue to offer great products to facilitate better working habits and enhance productivity. Our Office Furniture Fittings segment includes a variety of new Monitor Arms, Smart Lifts – Height Adjustable Desks, Computer Keyboard Stations, CPU Stations, Cable Organisers and other accessories.

### **EBCO – SIMPLIFYING LIVES**

Known for quality with value for money pricing and a wide range, we truly embody the drive to Make in India – we make almost all products under 7 verticals at our plants here in India. Over the past two years, we have significantly widened our range of products with a special focus on the Architectural Hardware and Window Fittings segments. Our newly introduced products include Pole Display Shelving System, Steelfix, Combination Locks, Drawer Slides & Hinges, Friction Stays, Sliding Window Locks and many more.

### **LIVSMART – INTELLIGENT HARDWARE FOR HOMES**

Our Kitchen Systems and Accessories segment includes Drawer Systems and Accessories, Corner Solutions, Overhead Systems, Midway Systems, Waste Bins, Roll Top Shutters and more. With a special focus on strengthening our Bedroom Furniture Fittings segment we have widened our range of products which includes Wardrobe Sliding Systems and Accessories, Pro Lift & Electric Bed Fittings and related products.

Our strengths in these segments include our broad product range, best-in-segment quality standards, cutting edge features and fair pricing.



## CERTIFICATIONS

Quality products, the protection of our environment and nurturing our people have always been our priorities.

As a company, we are BIFMA Compliant. Our manufacturing plant at Vasai houses our Design and Development department, Tool Room, Press Shop, Hardening, Phosphating and Assembly departments and has been certified in ISO 9001: 2015 – Quality Management System, ISO 14001: 2015 – Environmental Management System, ISO 45001:2018 – Occupational Health and Safety Management System.



ISO 9001: 2015 Quality Management Systems  
ISO 14001: 2015 Environmental Management Systems  
ISO 45001 : 2018 Occupational Health and Safety Management Systems

# BIFMA

Our products are BIFMA compliant.



BIS Certification

Bureau of Indian Standards



**LISTED**  
R40012

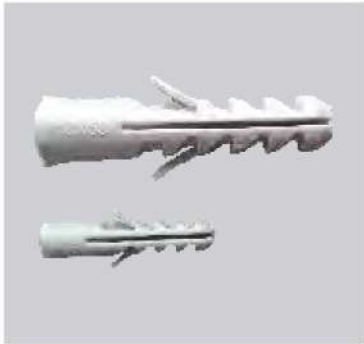

## CONTENTS

DRAWER SLIDES & HINGES .....	8 - 11
GENERAL HARDWARE .....	12 - 16
JOINERY FITTINGS & SCREWS .....	17 - 18
FURNITURE LOCKS .....	19 - 23
RETAIL DISPLAY SYSTEMS .....	24 - 26
WINDOW, DOOR & GLASS HARDWARE .....	27 - 35





# DRAWER SLIDES AND HINGES

## DRAWER SLIDES

01

**PREMIUM SLEEK TELESCOPIC SLIDES - SOFT CLOSE**



**WIDEST RANGE:**

- Over 600 variations.
- Load Capacity from 10kg to 125kgs.
- Lengths from 200mm to 900mm.

**ADVANCED TECHNOLOGY:**

- Available in Regular, Soft-Close, Push-Open & Push + Soft mechanisms.

**CYCLE TESTED:**

- As per BIFMA & FIRA norms

03

**FULL PANEL DRAWER SLIDE**

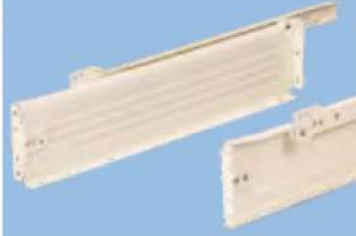

07

**SLEEK TELESCOPIC DRAWER SLIDE (I) 35/45 KG**



04

**FULL PANEL QUICK FIT**



08

**SLEEK TELESCOPIC DRAWER SLIDE - 45KG (SS304)**



02

**BOTTOM MOUNTING DRAWER SLIDE**



05

**SLEEK TELESCOPIC DRAWER SLIDE - 35KG**



09

**STEEL FURNITURE DRAWER SLIDE**



06

**SLEEK TELESCOPIC DRAWER SLIDES - (I) 30**



10

**SLEEK TELESCOPIC DRAWER SLIDE (I) 35 - SOFT CLOSE**



**01** - Size (L):300, 350, 400, 450, 500, 550, 600 mm. Load Capacity: 45kgs Finish: Zinc White. **02** - Size: 300, 350, 400, 450, 500 mm. Load Capacity: 20kgs Finish: Ivory, Brown & Black. **03** - Size (H): 54mm & 86mm (L): 300-500mm. Size (H): 125mm (L): 300-550mm. Size (H): 150mm (L): 350-500mm. Capacity: 25kgs. Finish: Ivory **04** - Size (H): 54, 86, 125mm (D): 400, 450mm (W): 400, 450mm Load Capacity: 25 kgs Finish: Ivory. **05** - Size (L): 350, 400, 450, 500, Load capacity : 35 Kgs. Finish: Zinc White/Zinc Black. **06** - Size 250, 300, 350mm. Finish: Zinc White Size 400, 450, 500mm. Finish: Zinc White/Zinc Black Capacity: 30kgs. **07** - Size For 35 Kgs (L): 200, 250, 300, 350, 400, 450, 500, 550, 600mm. Finish: Zinc White/Zinc Black. Size (L): 750, 900mm. Finish: Zinc White. Size For 45 Kgs (L): 250, 300, 350, 400, 450, 500, 550, 600, 750, 900mm. Finish: Zinc White/Zinc Black. **08** - Size (L): 400, 450, 500, 550mm. Load Capacity: 45kgs. Finish: Stainless Steel. **09** - Size (L): 400, 450, 500, 550mm. Load Capacity: 35kgs. Finish: Zinc White. **10** - Size (L): 300, 550, 600 mm. Finish: Zinc White. Size (L): 350, 400, 450, 500 mm. Finish: Zinc White/Zinc Black.



## DRAWER SLIDES

### CONCEALED DRAWER SLIDE SLIM - 2

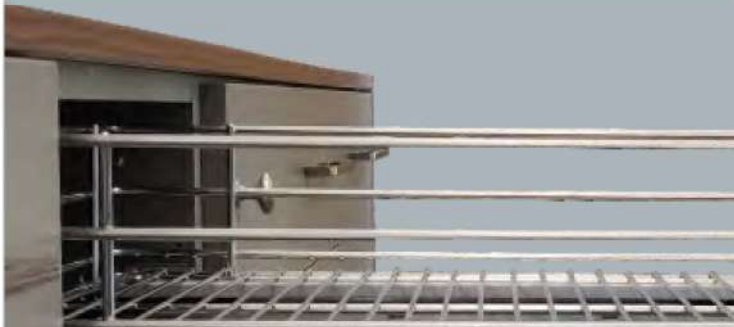

#### FEATURES

- Highly stable and uses minimal space below the drawer (27mm clearance).
- Available with fascia bracket for wooden drawers and without fascia bracket for kitchens baskets.
- Full extension with soft close and tool free assembly and removal of drawers.
- Unique 3D adjustable clip for perfect alignment.
- Size: 300, 350, 400, 450, 500, 550mm.
- Finish: Zinc White.

Load Capacity - 35 Kgs

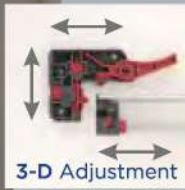

**11** - Size (L): 400,450,500mm.  
Load Capacity: 45kgs Finish: Stainless Steel

**12** - Size (L): 400,450,500 mm  
Load Capacity: 45kgs. Finish: Zinc White.

**13** - Size (L): 450, 500, 600, 750, 900 mm. Load Capacity: 90kgs. Finish: Zinc White.

**14** - Size (L): 450, 500, 550, 600, 750, 900 mm. Load Capacity: 125kgs. Finish: Zinc White.

**15** - Computer Keyboard Slide Size (L): 350. Load Capacity: 35kgs. Finish: Zinc White/Zinc Black.  
Computer Keyboard Slide Eco & (I) Series - Size (L): 350 mm. Load Capacity: 12kgs. Finish: Zinc White/Zinc Black.

**16** - Size (L): 250mm. Load Capacity: 12kgs. Finish: Black.

**17** - Size (L): 200, 300, 375, 420 mm. Load Capacity: 12kgs. Finish: Zinc White/Zinc Black.

**11**

SLEEK TELESCOPIC DRAWER SLIDE SS 304 SOFT CLOSE



**13**

HEAVY DUTY DRAWER SLIDE - 90KG



**15**

COMPUTER KEYBOARD SLIDE / COMPUTER KEYBOARD SLIDE ECO & (I) SERIES

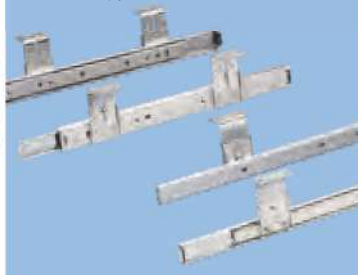

**12**

PREMIUM SLEEK TELESCOPIC SLIDE - PUSH OPEN



**14**

HEAVY DUTY DRAWER SLIDE - 125KG



**16**

COMPUTER KEYBOARD SLIDE WITH FULL EXTENSION



**17**

TWO WAY SLIDE





# DRAWER SLIDES AND HINGES

## HINGES



**01** E SOFT LINEAR HINGE - 3D

**07**  
HINGE SLOW MOTION - SS304  
(with 4 Hole Mounting Plate)



**12**  
FOLDING DOOR HINGE



**08**  
HINGE SLOW MOTION



**13**  
FOLDING DOOR HINGE (I)



**02**  
SLIP ON HINGE - EURO



**03**  
CLICK ON HINGE (I)



**04**  
EURO SLIP-ON  
HINGE-SS 304 WITH  
4-HOLE MOUNTING PLATE



**09**  
HINGE PUSH OPEN



**14**  
BLIND CORNER  
HINGE - EURO



**01** - Max Opening: 105°. Shutter Size: 35" x 24" (900mm x 600mm) for 2 hinges. Shutter Thickness: 14 to 22mm. Shutter Cavity: Ø35mm, 11.4mm deep. Finish: Nickel plated & Titanium. **02** - Max opening: 105°. Shutter size: 34" x 22" (850mm x 550mm) for 2 hinges. Shutter Thickness: 16mm to 19mm. Shutter cavity: Ø35mm, 12mm deep, 4mm from edge. Available in 4 hole mounting plate. **03** - Max Opening: 105°. Shutter Size: 34" x 22" (850mm x 550mm). Shutter Thickness: 16 to 19mm. Shutter Cavity: Ø35mm, 12mm deep, 4mm from edge. **04** - Max Opening: 105°. Shutter Size: 34" x 22" (850mm x 550mm). Shutter Thickness: 16 to 19mm. Shutter Cavity: Ø35mm, 12mm deep, 4mm from edge. **05** - Max Opening: 105°. Shutter Size: 34" x 22" (850mm x 550mm) for 2 hinges. Shutter Thickness: 16 to 19mm. Shutter Cavity: Ø35mm, 12mm deep, 4mm from edge. **06** - Max Opening: 105°. Shutter Size: 34" x 22" (850mm x 550mm). Shutter Thickness: 16 to 19mm. Shutter Cavity: Ø35mm, 12mm deep, 4mm from edge. **07** - Max. opening: 105°. Shutter size: 34" x 22" (850 mm x 550 mm) for 2 hinges. Shutter thickness: 16 to 19mm. Shutter cavity: Ø35mm, 12mm deep, cavity 4mm from edge. **08** - Max Opening: 105°. Shutter Size: 34" x 22" (850mm x 550mm). Shutter Thickness: 16 to 19mm. Shutter Cavity: Ø35mm, 12mm deep, 4mm from edge. **09** - Max. Opening: 105°. Shutter Size: 34" x 22" (850mm x 550mm) for 2 hinges. Shutter Thickness: 16mm to 19mm. Shutter cavity: Ø35mm, 12mm deep, 4mm from edge. **10** - Max. opening: 125°. Shutter size: 34" x 22" (850 mm x 550 mm) for 2 hinges. Shutter thickness: 16 to 19mm. Shutter cavity: Ø35mm, 13mm deep, cavity 4mm from

**05**  
HINGE SLOW MOTION - 3D



**10**  
125° Hinge



**15**  
BLIND CORNER HINGE -  
SOFT CLOSE



**06**  
EURO SLOW MOTION HINGE  
- 2/4 HOLE MOUNTING PLATE



**11**  
MINI HINGE



**16**  
45° CROSS CORNER  
HINGE - EURO



edge. Finish: Nickel plated. **11** - Max Opening: 100°. Shutter Size: 24" x 18" (600mm x 450mm). Shutter Thickness: 12 to 18mm. Shutter Cavity: Ø26mm, 10mm deep, 4mm from edge. **12** - Max Opening: 180°. Shutter Thickness: 15 to 23mm. **13** - Max Opening: 180°. Shutter Thickness: 16 to 26mm. **14** - Max Opening: 105°. Shutter Size: 34" x 22" (850mm x 550mm). Shutter Thickness: 16 to 19mm. **15** - Max Opening: 100°. Shutter Size: 34" x 22" (850mm x 550mm). Shutter Thickness: 16 to 19 mm. **16** - Max Opening: 105°. Shutter Size: 34" x 22" (850mm x 550mm). Shutter Thickness: 16 to 19 mm.

## HINGES

### PIVOT HINGE WITH SPRING (FOR STEEL FURNITURE)

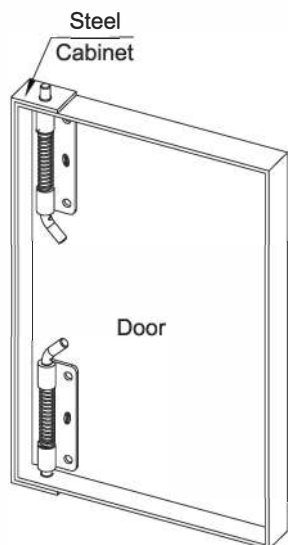

- Ideal for steel cabinet.
- Spring loaded latch mechanism for long lasting uses.
- Easy to use.

### SPECIALITY HINGES

25

CRANKED HINGE



30

GLASS DOOR HINGE  
(SOFT CLOSE) - Ø 35



22

THICK DOOR HINGE -  
SOFT CLOSE



26

SPRING LOADED HINGE



31

270° HINGE



17

PIVOT HINGE



19

165° HINGE (I)



23

THICK DOOR HINGE  
15-35mm SOFT CLOSE



27

INLINE HINGE



### HINGE ACCESSORIES



DOWEL FOR  
HINGE - EURO



Ø 35MM COVER

18

155° HINGE - SOFT CLOSE  
(Zero Protrusion)



20

165° HINGE -  
SOFT CLOSE



23

SHORT ARM HINGE WITH  
4 HOLE MOUNTING PLATE



28

GLASS HINGE - INSET



27 - Max Opening: 180°. Finish: Nickel plated, White Mat, Black, Brown, Anthracite

28 - • Ideal for folding shutters • Spring loaded with adjustment. • Used in walk in closets.

29 - Shutter Size: 800mm x 350mm. Shutter Thickness: 4 to 6mm. Shutter Cavity: No cavity required.

30 - Max. opening : 100°. Shutter size : 600mm x 350mm. Shutter Thickness: 4 to 6mm. Shutter cavity : Ø26mm, 4mm from edge.

31 - Max. opening : 105°. Shutter size: 600mm x 400mm. Shutter Thickness: 4 to 6mm. Shutter cavity : Ø35mm, 4mm from edge.

32 - Max. opening : 270°. Shutter size : 34" x 22" (850mm x 550mm). Shutter Thickness: 16 to 19mm. Shutter cavity: Ø35mm, 12mm deep.

### CABINET HINGE



21

THICK DOOR HINGE



24

SHORT ARM HINGE WITH  
4 HOLE MOUNTING  
PLATE / SOFT CLOSE



29

GLASS DOOR HINGE - Ø 26



17 - Max Load: 6 Kgs/set Finish: SS 304. 18 - Shutter Size: 600mm x 900mm). Shutter Thickness: 17 to 21 mm. Shutter Weight: 4-6 Kgs. 19 - Max Opening: 165°. Shutter Size: 85" x 24" (2135mm x 600mm). Shutter Thickness: 16 to 26 mm. Shutter Cavity: Ø35mm, 12mm deep, 4mm from edge. 20 - Max Opening: 165°. Shutter Size: 85" x 24" (2135mm x 600mm). Shutter Thickness: 16 to 26 mm. 21 - Max Opening: 100°. Shutter Size: 34" x 22" (850mm x 550mm). Shutter Thickness: 18 to 30mm. Shutter Cavity: Ø40mm, 14mm deep, 4mm from edge. 22 - Max Opening: 95°. Shutter Size: 34" x 22" (850mm x 550mm). Shutter Thickness: 18 to 30mm. Shutter Cavity: Ø40mm, 14mm deep, 4mm from edge. 23 - Shutter Cavity: Ø35mm. Max Opening: 95°. Shutter Thickness: 15 to 35mm. . 24 - Max Opening: 100°. Shutter Size: 34" x 22" (850mm x 550mm) for 2 hinges. Shutter Thickness: 16 to 19mm. Shutter Cavity: Ø35mm, 14mm deep, 4mm from edge. 25 - Max Opening: 100°. Shutter Size: 34" x 22" (850mm x 550mm) for 2 hinges. Shutter Thickness: 16 to 19mm. Shutter Cavity: Ø35mm, 14mm deep, 4mm from edge. 26 - Max Opening: 180°. Finish: Nickel plated, White Mat, Black, Brown, Anthracite



# GENERAL HARDWARE

## FOLDING TABLE MOUNT TWIN



- Space saving solution for a fold-away table with special release knob feature that folds when not in use.
- Ideal for multiple applications - Home, Offices, Restaurants or Cafeteria.
- Does not include Table Top.
- Recommended Table Top Size : 1500 (W) x 600 (D) x 18-25 (T) mm
- Max. Load : 25kg for 18mm board
- Connecting Rod Length : 1100mm
- Finish : Black

04

## TABLE BRACKET RECESSED



09

## AC MOUNTING BRACKET



05

## TABLE BRACKET DAMPER



10

## TABLE LIFT - 200 TABLE LIFT - 200 WITH DAMPER



01

## FOLDING TABLE MOUNT



Open



Folded

06

## TABLE BRACKET MINI



## TABLE LIFT 300 - WITH DAMPER

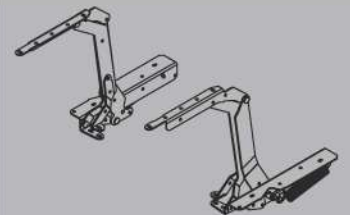

02

## FOLDING UTILITY TABLE



03

## TABLE BRACKET



07

## TABLE TOP FOR TABLE BRACKET



11

## PRO-LIFT / PRO LIFT PROGRESSIVE

PRO LIFT  
SOFT CLOSE



**01** - Size: Ø76mm, 154 x 154mm. Finish: Black. **02** - Size: 600, 750, 900 & 1200mm. Max. Load: 70 kgs. Finish: Anthracite. **03** - Size: 300, 400, 500, 600mm. Max. load: 100kgs (300/400/500mm) & 150kgs (600mm). Finish: Anthracite/Brown/White Matt. **04** - Size: 300, 400, 500mm. Max. Load: 100 kgs. Finish: Anthracite/Brown/White Matt. **05** - Size: 200, 400mm. Max. Load: 20N & 40N. Finish: Anthracite. **06** - Size: 250, 325mm. Finish: Anthracite/Brown/White Matt. **07** - Size (mm): 400(D) x 600 (W) x 18(T) Compatible with Table Bracket TB300; 400(D) x 700(W) x 18(T) Compatible with Table Bracket TB300; 575(D) x 800(W) x 18(T) Compatible with Table Bracket TB400; 570(D) x 800 (W) x 18(T) Compatible with Table Bracket TB500. Finish: Frosty White/Walnut. **08** - Size: 340mm - 500mm. Max. Load: 120 kgs. Finish: Black. **09** - Size: 500mm. Max. Load: 120 kgs. Finish: White Texture. **10** - Load Capacity 11 kgs.max. Recommended Table Size: 4 x 2 feet. Lift up by 200mm. Finish: Table Lift 200- Black/Anthracite. Table Lift 200 with Damper - Anthracite. **11** - Force: 60N, 80N, 100N, 120N, 150N. Pro-Lift/Pro-Lift Progressive available in 200N & 250N as well. **12** - Finish: Anthracite. Force: 250N, 300N, 350N. **13** - Max. Load: 4kgs with one stay. 7kgs with 2 stays. Finish: Nickel Plated.

08

## MULTI UTILITY FOLDING BRACKET

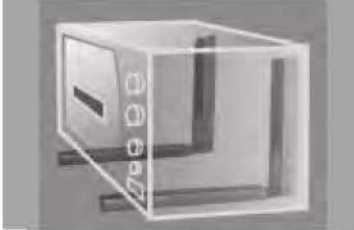

12

## PRO LIFT HEAVY DUTY





**13** CABINET STAY



**PLINTH BASE - ADJUSTABLE**

Load Capacity: 500kgs  
Finish: Zinc Yellow

**19** SOFA BASE 332 & 282

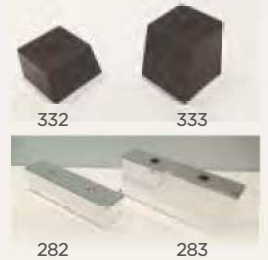

**14** CABINET STAY - HEAVY



**PLINTH SCREWS**

Plinth Screw - BB

Plinth Screw

**20** PEDESTAL CASTOR/  
PEDESTAL CASTOR RECESSED



**15**  
LID STAY



**16**  
FLAP STAY



**18**  
BASE PLINTH

**CABINET SHELF SUPPORT**



CSS 1 CSS 1N CSS 2

**PIN SHELF SUPPORT**



PSS 1 PSS 2



**FURN FELT**

With Pin/Adhesive



**17**  
BALL HEAD PLINTH SCREW

BHP-870 BHP-840



**PLINTH BUSH**



**PLINTH BUSH WITH PIN**



**PLINTH PIN**

**21**  
ADJUSTABLE GLASS  
SHELF SUPPORT



AGSS1/2 AGSS3 AGSS4

**GLASS SHELF SUPPORT &  
GLASS SHELF SUPPORT (SCREW)**



GSS 1 GSS 2 GSS 3



**22**  
GLASS SHELF  
BRACKET

**14** - Max. Load: 6kg/each. Finish: Nickel Plated. **15** - Finish: SS304 **16** - Size: Regular (180mm) / Large (230mm)/ Ex-Large (280mm). Finish: Plated/ Brown. Load: 12kgs. **17** - Load Capacity: 800kgs/ piece. **18** - Load Capacity: BP 16 - 1000kgs / piece, BP 1418 - 1200kgs / piece. **19** - Easy to mount foot base for sofas and cabinets. Size: SB 332: 70x70x45mm, SB 333: 70x70x75mm, Finish: Brown. SB282: 45x200x45. SB283: 45x200x75. Finish: Chrome Plated. Load Capacity: 500kg/pc. **20** - Load Capacity: Static - 500kgs, Dynamic - 300kgs. Set Height: 28mm (PC28), 10mm (PCR60). Finish: Black. **21** - AGSS1/2 - Size: 6mm - 12mm. Finish: Silver/Nickel Plated. AGSS3 - Size: 5mm - 15mm, AGSS4 - Size: 3mm - 20mm. Finish: Chrome Plated/Nickel Plated. **22** - Size: 8mm, 10mm, 12mm. Finish: Nickel Plated Satin



# GENERAL HARDWARE

## SMART KEY BOX



### Combination Locks specifications:

- Keyless Operation
- Up to 10,000 combinations
- Code setting without tools
- Code finding from the front by recovery key
- Anti-Bacterial Plastic Key Cap with Microban® Technology inhibits bacterial growth by 99%
- Can hold 20Keys
- Ideal application in Office, Residences, Clubs, Gyms, Wallet Parking etc.
- Key box dimension: 200x160x75.5mm
- Finish: Anthracite / White



30

### VENTILATION GRILL - DIA 40MM



31

### VENTILATION GRILL - RECTANGULAR



23

### WALL SHELF ROD - HD



26

### GLASS CORNER HOLDER / GLASS CORNER HOLDER - ECO



32

### CUPBOARD LATCH



24

### WALL SHELF ROD



25

### WALL SHELF ROD ADJUSTABLE



27

### GLASS SIDE HOLDER



28

### GLASS CLAMP



33

### TONGUE HANDLE



34

### GLASS HANDLE



29

### SPRING CLIP



### BOTTOM PANEL SUPPORT - 6MM



**23** - These are heavy duty, plastic cover moulded, built in with plug and with better grip. **Size:** Ø10 x 100, Ø10 x 145, Ø 14 x 140. **Finish:** Brown.  
**24** - **Size:** 100mm,150mm. **Finish:** Zinc Plated Yellow. **25** - **Size:** 150, 200, 250mm. **Finish:** Zinc Plated White. **26** - **Size:** 4mm. **Finish:** Ivory/Clear.  
**27** - **Size:** 4mm. **Finish:** Ivory/Clear. **28** - **Size:** 4mm. **Finish:** Clear.  
**29** - **Max. Shutter Size:** Cabinet: 850x550mm (34"x22"), Cupboard: 2000x750mm (80"x30") **Finish:** Zinc Plated White. **30** - **Finish:** Black/Grey/White. **31** - **Size:** 34 X 168mm. **Finish:** Black/Grey/White.  
**32** - **Size:** 56, 96, 150mm. **Finish:** Zinc Plated Black & White/SS304.  
**33** - **Size:** 50x40mm, 82x40mm. **Finish:** Black/Brown/Silver/ White Matt.  
**34** - **Finish:** Chrome Plated. **Glass Shutter Thickness:** 4-6mm

## CABINET HANGER CONCEALED

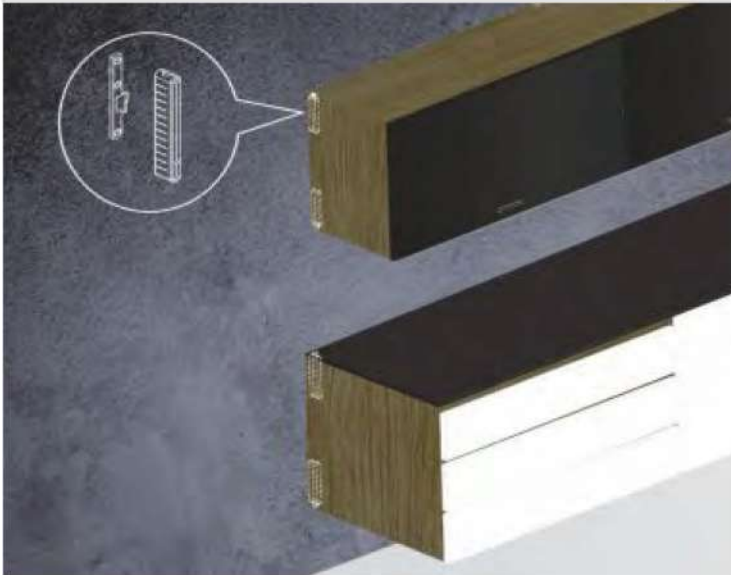

- Heavy duty cabinet hanger.
- Ideal for kitchen cabinets (base unit & wall units)
- Bathroom vanity units & similar applications.
- Size: 141x 21mm.
- Load Capacity: 300kgs./pair.
- Min. Panel Thickness: 18mm.
- Finish: Mocha.
- Slides in for easy storage.

### 36 HANGER BRACKET



### 37 HANGER / HANGER PLATE



### 38 ADJUSTABLE CORNER BRACKET



### BUMPERS

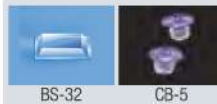

SAFETY CORNER BUMPER S  
SCB-S 35  
Size: 35X35X25mm

SAFETY CORNER BUMPER R  
SCB-R 41  
Size: 41X41X15mm

SAFETY DOOR SPACER  
SDS 2560  
Size: 88X70X22mm

### 39 DOOR SEAL PROFILE

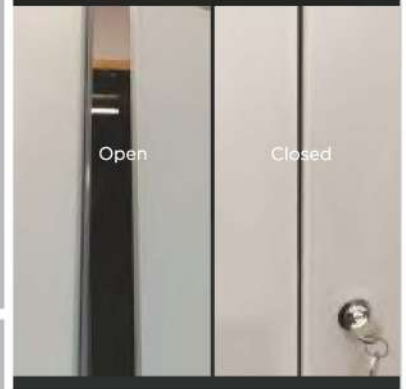

### 40 MIRROR HOLDER



**35** - Ideal for hanging bags, helmets etc. beneath the table. Easy to mount under or on the side wall of desk. Size: 100x20x3mm. Finish: White

**36** - Size: Regular/ Mini. Load Capacity: 45kgs (Regular), 30kgs (Mini). Finish: Black/Silver.

**37** - Size: Hanger - 60mm, 80mm, 100mm. Load Capacity: Hanger - 80 kgs/piece. Finish: Zinc Plated White

**38** - Load Capacity: 60 kgs/piece. Finish: Plated / White

**39** - Finish: Silver/Anthracite

**40** - Glass Thickness: 4 to 8mm. Finish: SS304.

### 35 BAG HOOK





# GENERAL HARDWARE

41

DOOR STIFFNER



WARDROBE LATCH



47

CORNER CLAMP



50

Safe Key



42

DOOR STIFFNER HD



45

BED CLAMP



48

MULTI CORNER BRACKET



51

PUSH OPEN FITTING - MAGNETIC



43

COVER FOR DOOR STIFFNER



46

BED CROSSBAR CLAMP / TELESCOPIC



49

TURN TABLE MECHANISM



52

MAGNETIC CATCH- DOT



44

SLIDING CABINET SHUTTER FITTING



AUTO BOLT LATCH



53

MAGNETIC CATCH-ULTRA SLIM



41 - Size: 2010mm. Finish: Aluminium/ Black. 42 - Size: 2010 mm. 43 - Size: 6mm. Finish: Opaline/ Silver. 44 - Finish: White/Brown. 45 - Size: 4" and 6". Load/Set: 1200kgs. Finish: Zinc Plated Yellow. 46 - Bed Crossbar Clamp Size: 140x64mm. Finish: Zinc Plated Yellow. 47 - Size: 38x 38x 38mm. 48 - Size: 165 x 165x 35mm. Finish: Black/White Matt/ Anthracite. 49 - Size: 100, 150, 200mm. Load Capacity: 50 kgs,75 kgs, 100 kgs. 50 - Size: 98 X 40mm. Finish: White./ Black / Ebco Blue. 51 - Stroke: 12mm/ 40mm. Push force/ Piece: 3.5kgs (12mm), 3kgs (40mm). Finish: Grey. 52 - Size: Ø8 x 10mm. Catch Plate provided. Pull force: 750gms. Finish: White / Mocha. 53 - Pull force: MC-US 1 - 2.25kgs, MC-US 1L - 3.25kgs, MC-US 2 - 5kgs, MC-US 2L - 5.50kgs, MC- I1 - 2.50kgs, MC- I1L - 2.75kgs.

POZI SCREWDRIVER BIT (MAGNETIC)



Two Way-Magnetic

CARBIDE STANDARD SHANK







**HIGH PRECISION FASTENERS**

- Ideal furniture fastener providing high pull-out resistance.
- Manufacture to international specifications and standards.
- Choice of diameters & lengths ensure proper selection for each application.
- Material: C-1022 steel heat treated case hardened or SS304 grade stainless steel.



Pozi Recess CSK Head Chipboard Screw



Pozi Recess CSK Head Screw with Saw-Thread



SS304 Pozi Recess Head Chipboard Screw



Pozi Recess PAN Head Chipboard Screw



Phil Recess CSK Head Drill Screw



Phil Recess PAN Head Drill Screw



M6 Allen Socket CSK Head Screw



Handle Fitting Screw

**STEEL FIX AND MINI FIX**



- New Steelfix Housing made out of MS is very strong & usable with existing ebco mini fix screws.

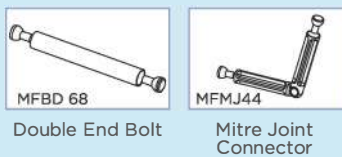
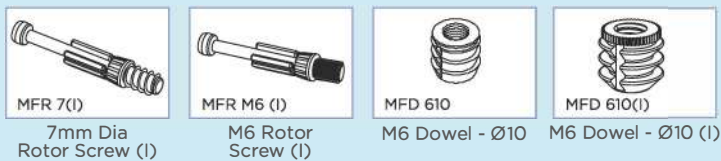
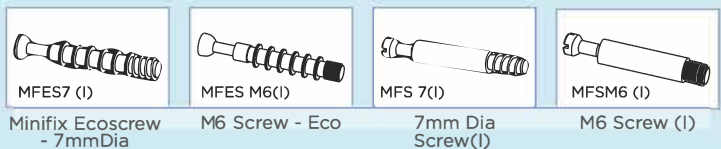
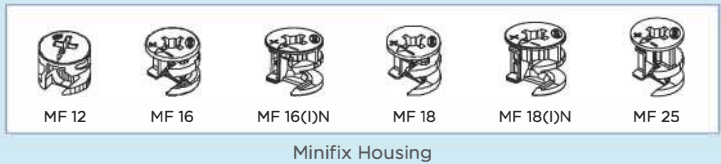
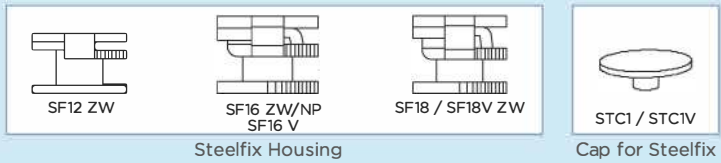



# JOINERY FITTINGS & SCREWS

**SELF TAPPING SCREWS (FLAT TIP)**



**CROSS NUT / BARREL NUT / SLEEVE NUT**



**04**

**ANCHOR PLUG WITH SCREW  
HEX HD/CSK HD**



**09**

**RIGHT ANGLE BLOCK**



**15**

**BLOCK CONNECTOR FITTINGS**



**DOWEL FIX**



**MODULAR FURNITURE SCREW  
Allen Head / Phillips Head**

**10**

**RIGHT ANGLE BLOCK - ECO**



**16**

**DOWELS**



**SELF TAPPING INSERTS**



**M10 PHILIPS HEAD SCREW & CAP**



**05**

**MAXI CONNECTOR**



**11**

**M4 SLEEVE CONNECTING SCREW**



**17**

**MODULAR CLIP**



**01**

**RIVET NUTS**



**06**

**TABLE CONNECTOR**



**12**

**M4 CONNECTING SCREW-  
ONE WAY**



**18**

**SHELF CAM**



**02**

**WALL PLUG**



**03**

**WALL PLUG 535**



**07**

**RIGHT ANGLE BRACKET/  
SS304**



**13**

**Ø5MM INSERT SCREW /  
INSERT SCREW KNURLED**



**19**

**CONCEALED SHELF  
SUPPORT**



**08**

**RIGHT ANGLE CONNECTOR**



**14**

**Ø 5 MM PLUG /  
Ø5MM INSERT**



**20**

**PUSH FIX**



**01** - Size: M3x8, M4x10, M5x11, M6x14, M8x15. Finish: Zinc Plated White. **02** - Size: 10x50, 6x30. Finish: Grey. **03** - Size: 5x35. Finish: White. **04** - For Hex & CSK Head: Size: M10 x 80/100/120/140/160mm. For CSK Head: Size: M8 x 60/80/100mm Finish: Ebco Blue. **05** - Bolt Length: 65, 100, 150mm. Nuts Length: 10 & 17mm Finish: Zinc White. **06** - Finish: Zinc Plated Black. **07** - Sizes: 20x20, 40x40, 60x60, 80x80, 100x100, 20x40, 80x26. Finish: Zinc Plated White, SS304. **08** - Sizes: 20x20, 40x40, 25x35. Finish: Zinc Plated White. **09** - Finish: Ivory. **10** - Finish: Black. **11** - Sizes: 21/29/33/41/47mm Finish: Nickel Plated. **12** - Sizes: Ø5x20/25/30/35/40mm. Finish: Nickel Plated. **13** - Finish: Opaline. **14** - Plug: Finish: White/Brown, Insert: Finish: White. **15** - Finish: White. **16** - Sizes: Ø6x20/25/30/35 & Ø8x30/35/40mm. Finish: Wooden. **17** - Finish: Zinc Plated White. **18** - Finish: Frosty White. **19** - Finish: Frosty White. **20** - Finish: Zinc Plated White.



# FURNITURE LOCKS

PREMIUM SERIES



## Special Features of Premium Locks

### MASTER KEY SYSTEM:

Each batch of locks can have master key which can open every different lock from the same batch.

### CORE REMOVAL SYSTEM:

Also known as 'Service Key' The core can be removed from a lock and is interchangeable with any type of locks from the premium series.

### SET LOCKS:

Has a possibility of providing set locks (several locks with same key no.) in same or different type of locks from the premium series.

### FOLDING KEY



- Unique Wave key technology.
- Thicker than any furniture lock key, reduces chances of key breaking.
- Easy serviceability.

### FLIP KEY



- Patented Design.
- Double Wave Key System.
- Complete folding.
- Flip to open & use.

### 5000 COMBINATIONS



### Premium Locks with "Active Pin System"



The Active Pin elevates the level of security to another level. It works instantaneously on unauthorised insertion of a different numbered key.

01

### MULTI PURPOSE LOCK - ROUND



Straight



Cranked

02

### SQUARE LOCK



Straight



Extended Bolt

03

### FRONT MULTI DRAWER LOCK

Wooden Drawer



Steel Cabinet



01 - Size: 22mm.

02 - Size : 22mm & 32mm. Extended bolt: Extension: 21.5mm & Width-19.5mm.

03 - Size: 22mm. Height: 480mm & 580mm. Pedestal lock with locking strip available for wood and steel furniture.

|| STEEL FURNITURE LOCKS



# FURNITURE LOCKS

## PREMIUM SERIES

04

CAM LOCK



Standard



Threaded ||

09

AUTO LATCH LOCK



LOCK CORE WITH 2 KEYS / 3 KEYS



05

CAMLATCH - STEEL FURNITURE ||



07

PEDESTAL LOCK



Wooden Drawer

Steel Drawer ||

10

PUSH & TURN LOCK



LOCK KNOB ADAPTOR / LOCK KNOB ADAPTOR DUMMY



06

CAM LATCH - WOOD 18-20



08

GLASS DOOR LOCK



Single

Double

11

PUSH LOCK



12

WARDROBE LOCK - 3 POINT



STORAGE LOCK - 2 POINT (INSET) 1200mm



13

WARDROBE LOCK - 2 POINT INSET / OVERLAY



04 - Size: Standard 22mm & Threaded 25 / 30mm. 05 - Size: 20mm.  
06 - Size: Padlock shackle. Diameter: Min. 4mm - Max. 6mm. For 18 to 20mm board. 07 - Size: 22mm. 08 - Sizes: 9mm & 12mm. 09 - Size: 22mm. 10 - Size: 22mm. 11 - Size: 22mm. 12 - Size: 22mm & 32mm. 13 - Size: 22mm & 32mm.

|| STEEL FURNITURE LOCKS



**Secutek**  
LOCKS

- Upto 200 combinations.
- Size: 20mm
- Option of Master Key system.
- Option of set locks.
- Die cast Body.

**CAM LOCK - STEEL FURNITURE ||**



Size: 0.6 - 0.9mm

**KEYS FOR SECUTEK LOCKS**



**25**

**SQUARE LOCK**



Metal Key

**29**

**MORTISE LOCK FOR SLIDING DOOR**



**14**

**MULTI PURPOSE LOCK - ROUND**

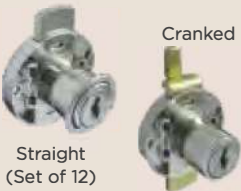

Straight (Set of 12)

Cranked

**18**

**PUSH LOCK**



**22 23**

**LOCK RECEIVER PLATE BRACKET FOR BOTTOM MOUNTING DR. SLIDE & FULL PANEL DR. SLIDE**



**FRONT MULTI DRAWER LOCK (480MM & 580MM)**



Metal Key

Size: 480, 580mm

**KEYS FOR TARGET LOCKS**



**15**

**SQUARE LOCK**



(Set of 12)

**19**

**PEDESTAL LOCK**



- Up to 200 combinations
- Click action mechanism
- Option of set locks
- Sheet Metal body
- Options of metal key/key with plastic cap

**26**

**CAM LOCK**



Standard

Threaded ||

**14** - Size: 22mm. Available with Metal Key.

**15** - Size : 22mm / 32mm. Available with Metal Key & Poly Carbonate Key.

**16** - Size: 22mm. Height: 480mm & 580mm.

**17** - Size: Standard 22mm and Threaded (16 / 25 / 30mm).

**18** - Size: 22mm.

**19** - Size: 22mm. Available with metal key.

**20** - Size: 22mm.

**21** - Available with longer key.

**22** - Finish: Nickel Plated.

**23** - Finish: Ivory.

**24** - Size: 22mm.

**25** - Size : 22mm & 32mm.

**26** - Size : Standard 22mm & Threaded (16 / 25 / 30mm).

**27** - Size: 22mm.

**28** - Size: 20mm.

**29** - Size: 22mm.

**16**

**FRONT MULTI DRAWER LOCK**



**20**

**MORTISE LOCK FOR SLIDING DOOR**



**24**

**MULTI PURPOSE LOCK - ROUND**

Straight



Cranked



Metal Key

**27**

**PUSH LOCK**



**28**

**PEDESTAL LOCK**



Metal Key

|| STEEL FURNITURE LOCKS



## FURNITURE LOCKS

## SPECIALITY LOCKS & STEEL FURNITURE LOCKS

### 30 SecuRite CUPBOARD LOCK



Dimple Key

Wave Key

Brass Key

### STEEL CABINET HANDLE/ STEEL CABINET LOCK CUM HANDLE



5000 COMBINATION

### 31 SecuRite DRAWER LOCK



Dimple Key

Wave Key

Brass Key

### CUPBOARD LOCK FOR - STEEL CABINET - 2 ||



### 32 SLIDING WARDROBE LOCK



### SLIDING DOOR LOCK || FOR STEEL CABINET (WITH HANDLE SET OF 2 NOS)



### CUPBOARD LOCK - STEEL CABINET ||



**30 - Size:** For Dimple Key & Wave Key - 23, 29, 35mm. For Brass Key - 20, 23, 25, 29, 32, 35mm.

**31 - Size:** For Dimple Key & Wave Key - 23 & 29 mm. For Brass Key - 16, 20, 23, 25, 29mm

**32 - Size:** 19mm & 25mm

### SLIDING WARDROBE LOCK (SIDE MOUNT) L/R



Left



Right



LOCKED



UNLOCKED

|| STEEL FURNITURE LOCKS



## SPECIALITY LOCKS & STEEL FURNITURE LOCKS

Note :  
Operating Instructions -  
Combination Lock  
Scan Here.



### 4 DIGIT COMBINATION LOCKS

- Four digit combination lock for keyless operation.
- Ideal Applications:
  - Corporate Office, BPOs, Banks.
  - Home Furniture - Wardrobe, Kitchen, etc.
  - Lockers - Club, Gym, Hostel, Factory, etc.
  - Retail Showrooms.
  - Display Units - Watches, Jewellery, Gadgets, etc.

- Replace any standard furniture lock to get instant keyless access.
- Once unlocked, the housing doubles as a knob; just rotate 90° to unlatch.
- The combination can be reset to any four digit number, providing up to 10000 possible combinations.
- Two levels of code setting: Combi-Public and Combi-Personal.
- Resolve forgotten secret code easily & rapidly with secret code retriever key.

#### 4 DIGIT COMBINATION LOCK - WOOD (L/R) ||



Size: 16 - 20mm  
Finish: Black / Grey



#### 4 DIGIT COMBINATION LOCK - WOOD (VERTICAL) (L/R) ||



Size: 16 - 20mm

#### 4 DIGIT COMBINATION LOCK - ZINC SINGLE GLASS DOOR/ 4 DIGIT COMBINATION LOCK - ZINC DOUBLE GLASS DOOR



Size: For 8 - 12mm Glass

#### 4 DIGIT COMBINATION LOCK - PEDESTAL (L/R) ||



Size: 16 - 20mm  
Finish: Black / Grey



#### 4 DIGIT COMBINATION LOCK - ZINC WOOD



Size: For 16 - 20mm

#### 4 DIGIT COMBINATION LOCK - STEEL CUPBOARD ||



#### 4 DIGIT COMBINATION LOCK - WARDROBE 2 POINT INSET



Size: For 16 - 20mm

#### 4 DIGIT COMBINATION LOCK - 2 POINT SWING (WITH ROD)



Size: For 16 - 20mm

#### TOUCH PAD COMBINATION LOCK (WOOD / PEDESTAL)

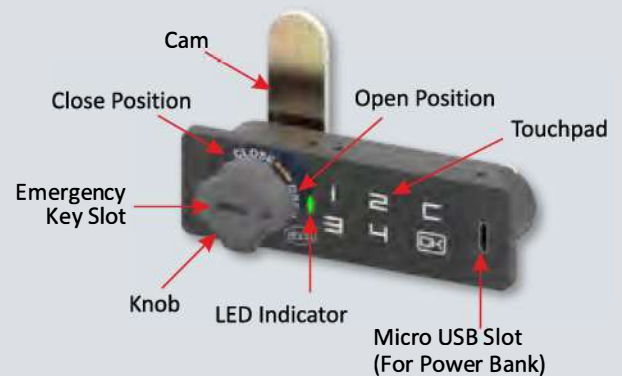

Public Mode



Keyless Operation



Emergency Key



Power Bank Support



Powered By 2 AAA Batteries

|| STEEL FURNITURE LOCKS



## RETAIL DISPLAY SYSTEMS

### POLE SHELVING SYSTEM



Aluminium Section



Height Adjustable Plinth



End Connector Set



Right Angle Connector



Small Shelf Support



Big Shelf Support



Tilting Shelf Bracket



Adjustable Glass Shelf Support



Concealed Slide Adaptor



Rectangular Rail Support

#### FEATURES

- This versatile Display System is equally suited for brand retail stores (Clothing, Apparels, Department) as well as walk-in wardrobes at home.
- It's highly flexible design enables to change the combination / layout of display without actually removing the pole systems installed.
- Multiple Adapter brackets can be chosen for Hangers, Shelves, Cabinets, Tilting Shelves, etc as per your desired application.
- Aluminium sections and die cast parts ensures strength and stability.
- Flexibility to mount the pole from floor to wall / ceiling as per the design requirement.





POLE SHELVING SYSTEM APPLICATIONS



Living Room



Study / Work from Home



Bedroom



Bathroom



# RETAIL DISPLAY SYSTEMS

## DISPLAY SHELVING SYSTEM - VERTICAL

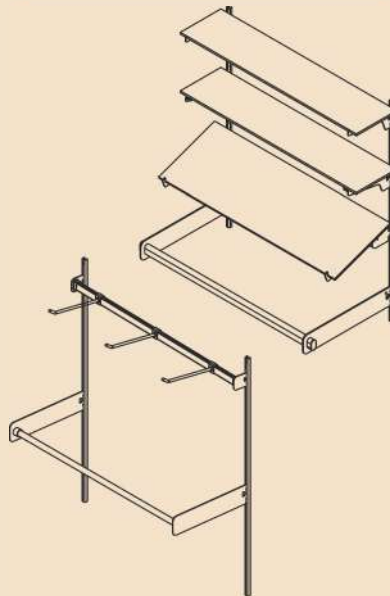

- Elegantly designed to suit different needs.
- Available in a variety of models and sizes.
- It is ideal if you have different items to display from time to time.
- Specially designed to impart maximum strength and to eliminate play.
- A unique stabilizer screw and nut holds the shelf in place.
- Available with an Aluminium Track for light weight load and Steel Track for heavy load.
- The tracks which support the shelves are screwed on to the wall, so that they blend well with the decor.
- Available for glass, wood shelves and hanger systems.
- Track, Wood Shelf Bracket, Glass Shelf Bracket, Hanger Holder Brackets, Hanger Rack, Rod Bracket and Glass Shelf Support with Screw & Nut are also available in **SS304**.

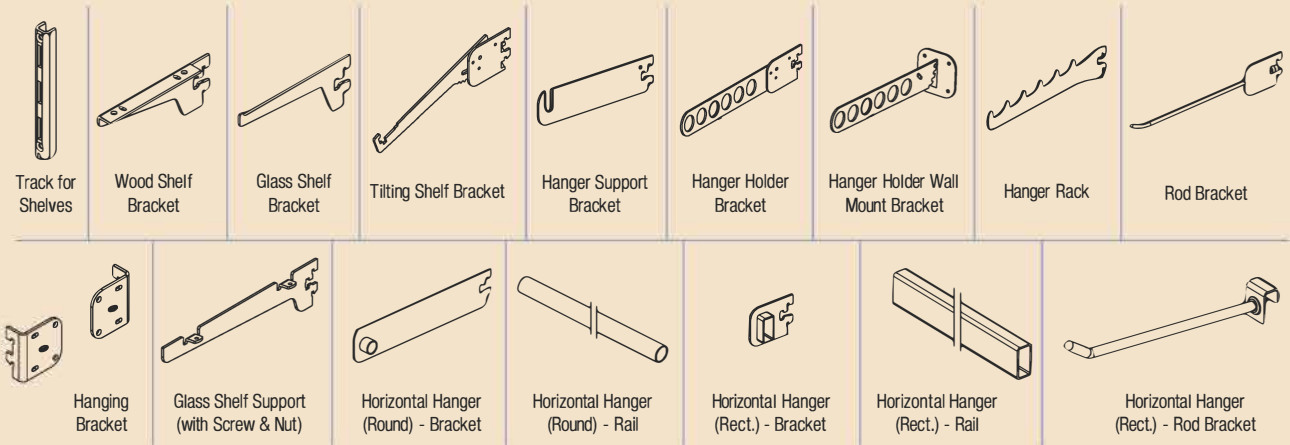

## DISPLAY SHELVING SYSTEM - HORIZONTAL

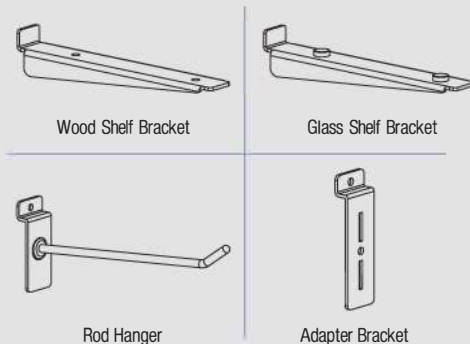



**01** FRICTION STAY - HI LOAD (SS304)

**FEATURES**

- Made of AISI 304 stainless steel.
- Pressure adjustable brake for stopping.
- Can be used for side hung horizontal axis opening ventilators, as well as top hung vertical axis opening windows.
- Stack Height - 15mm
- Applicable in wooden, aluminium or UPVC windows.
- Self cleaning design.
- Also available in independent left and right hand working for better closing and alignment.
- Load capacity: 21-30Kg

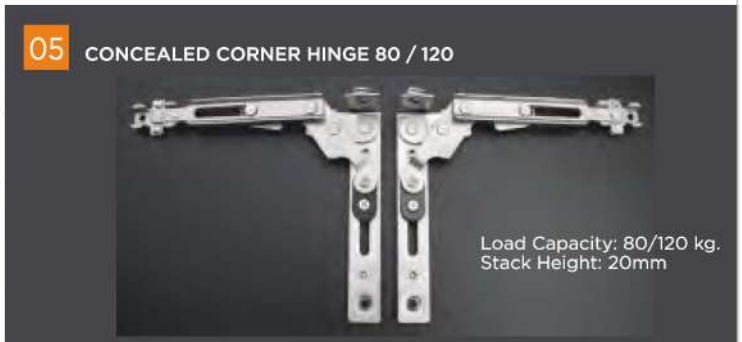

**05** CONCEALED CORNER HINGE 80 / 120

Load Capacity: 80/120 kg.  
Stack Height: 20mm



**06** FRICTION STAY HEAVY DUTY (SS304)

Load Capacity: 80 kg.  
Stack Height: 16.5mm



**07** FRICTION CATCH (SS304)



**10** WINDOW HANDLE HIGH / LOW



**08** WINDOW HANDLE - EURO



**11** WINDOW HANDLE - HEAVY (L/R)



**09** EURO HANDLE - 4 HOLE

**01** - Size: 10", 12", 14" **02** - Size : 8", 16", 20", 24", 28". **03** - Size : 12", 14". **04** - Size : 10", 12", 14". **05** - Load : 80/120 Kgs. **06** - Size : 20", 24", 28". **07** - Size : 8", 10", 12". **08** - Finish: Brown/Black/Window White/Silver/White Matt/ Champagne Gold. **09** - Finish: Brown/ Black/Window White/ Silver/White Matt/ Champagne Gold. **10** - Finish: Brown/ Black/Window White/ Silver/White Mat/ Champagne Gold. **11** - Finish: White/ Black.

**02** FRICTION STAY SS304

Load Capacity: 10-40 kg.  
Stack Height: 8": 15mm,  
16"-28": 18mm



**03** FRICTION STAY 2221  
FRICTION STAY 2221 (Bevelled)  
(SS304)

Load Capacity:  
12" - 25kg, 14" - 30kg  
Stack Height: 21mm.



**04** FRICTION STAY 1319  
(SS304)

Load Capacity:  
10" - 18kg, 12" - 22kg,  
14" - 25kg  
Stack Height: 19mm.





# WINDOW, DOOR & GLASS HARDWARE

**12** ALUMINIUM WINDOW HANDLE - DELUXE 2



**16** MORTISE WINDOW HANDLE WITH LOCK 3



TRANSMISSION LOCK STRIP FOR SWING DOORS / SLIDING DOORS



For Swing Doors For Sliding Doors

SLIDING WINDOW LATCH CATCHES

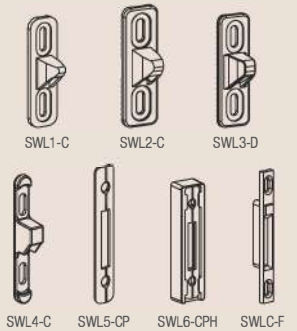

**13** WINDOW-DOOR HANDLE WITH PUSH LATCH



**17** MORTISE WINDOW HANDLE - SHORT NECK



- Available in three lengths with two & four locking points.
- Can be used for both left & right hand locking windows.
- Compatible with ebco Mortise Window Handle with Lock (AWH-DMLT)

**22** SLIDING WINDOW LATCH



**14** RECESSED MORTISE HANDLE



**18** ALUMINIUM DOOR HANDLE



CONNECTOR ROPE FITTING



**23** SLIDING WINDOW LATCH - CLICK FIT



**15** MORTISE WINDOW HANDLE -3



**19** ALUMINIUM CORNER CLEAT



CRESCENT LATCH



**24** SLIDING WINDOW LATCH - CLICK FIT LONG



**12** - Finish: White/ Black. **13** - Finish: White/ Black. **14** - Finish: White/ Black. **15** - Finish: White/Black. **16** - Finish: White/ Black. **17** - Finish: White/ Black. **18** - Finish: White/ Black. **19** - Size: Big-36mm x 13.5mm thk. Small-22mm x 10.4mm thk. **20** - Finish: White/ Black. **21** - Finish: White/Brown/ Grey/Black. **22** - Finish: Brown/Black/ Window White/Silver/Champagne Gold. **23** - Finish: Window White/ Black/ Champagne/Brown. **24** - Finish: Window White/Black/ Champagne/ Brown. **25** - Finish: Brown/Black/ Window White/ Silver/Champagne Gold.

**20** CRESCENT LATCH 3



**21** SLIDING WINDOW LOCK 1925



**25** SLIDING WINDOW LATCH - EASY



## PRESTO - DOOR KNOB LOCK **PRESTO**



### AVAILABLE FINISHES



CP



NS



AQ



BS

### BORING KIT FOR PRESTO LOCK



Size : 23mm & 42mm



TO OPEN:  
SIMPLY PRESS DOWN  
ON THE TOP CAP



Opening Tool



TO CLOSE:  
LET GO OF THE TOP CAP

- Door knob with push button locking.
- Press button to latch from inside until unlocked by key or by inside knob.
- Separate opening tool available for unlocking.
- Dimpled keys.
- For 30-45mm door thickness.
- 1,00,000 cycles tested.
- Available in Chrome Plated, Nickel Plated Satin, Antique Brass & Brushed Steel.

## MORTISE DOOR LOCK SET2 - ECO



Unlocked

Locked

- Keyless for (Bathroom) and One Side Key for (Bedroom) version.
- Easy reversible latch. Key can be removed easily in locked and unlocked position.
- Suitable for swing door, wood & metal doors.
- Steel Handle Case.

## SLIDING DOOR LOCK - WOOD, SWING DOOR LOCK - WOOD / ALUMINIUM.



Sliding Door Lock

Swing Door Lock

## DOOR VIEWER



## DOOR WEDGE



## DOOR LATCH SS 304



## TURN LATCH



## SECURITY DOOR LATCH





# WINDOW, DOOR & GLASS HARDWARE

## SLIDING DOOR FITTING

### WOOD SLIDING FOLDING FITTING

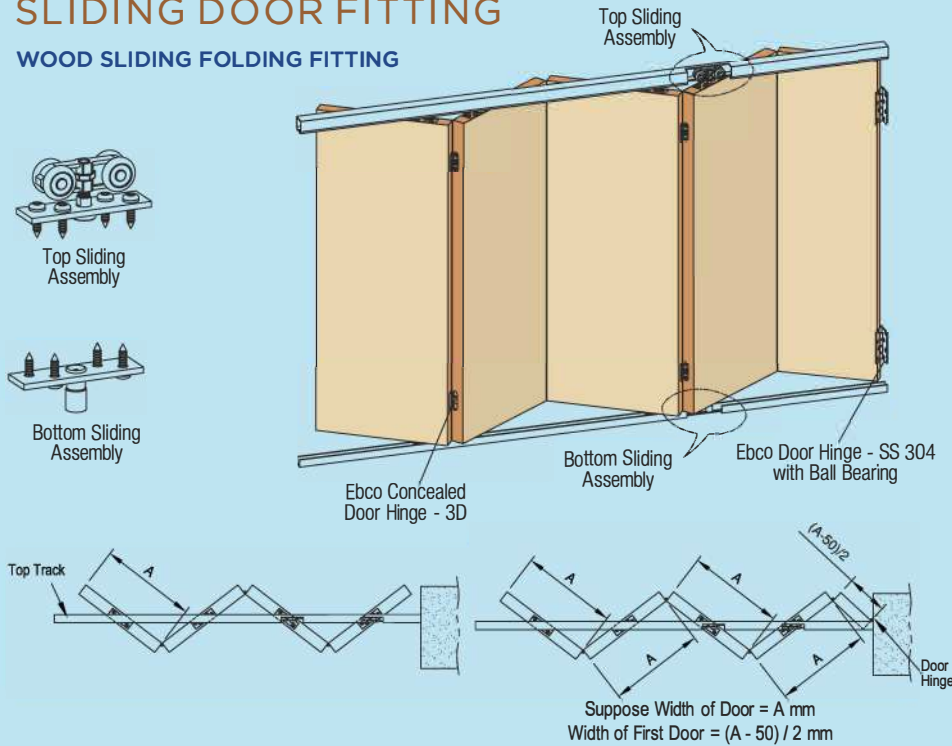

### SLIDING DOOR FITTING 100 SOFT CLOSE



### SLIDING DOOR FITTING 60 SOFT CLOSE & AUTO RETURN



### DOOR OPENER PEDAL/ DOOR OPENER BRACKET



- Ebco Door Opener Pedal / Bracket is an ideal solution, which eliminates the use of hand to open the door. Ideal for offices, hospitals, retail outlets, etc.
- Prevents contamination and spread of germs/ viruses.
- Wall bumper to protect the wall from damage.
- Curved tooth design ensures better grip.
- To be used in commercial latch-less doors.



SLIDING DOOR FITTINGS - STANDARD



SLIDING DOOR FITTINGS - GLASS



SLIDING DOOR FITTINGS - FLUSH



SOFT CLOSE KIT FOR SDF 125

- Single slide with bi-directional soft closing /automatic door closing function.
- Quick fit door installation and release.
- Adjustable soft closing speed and travel according to the door weight.
- Maximum soft closing travel: 115mm.
- Weight Capacity: 100kg (SDF 100 SC) & 30-60kg (SDF 60 SC AR)
- Door Thickness: Min. 30mm.
- Door Height Adjustment:  $\pm 3$ mm with Quick Release Base.

- 28 • Made out of SS304, the hinges are designed with precision ball bearings.
  - Suitable for doors of different sizes and weight.
- 29 • Ideal for flush wooden door applications.
  - 3-dimensional adjustment function allows vertical, horizontal and depth adjustment after hinge is installed.
  - 300,000 cycles tested.
  - Cover hides all screw for aesthetic looks.
  - Max door weight (for 2 hinges) - 40/80/120/80 Kgs
  - Min door thick - 35/40/45/40 mm
  - Max Door Width-850/1000/1400/1000 mm

### 28 DOOR HINGES - SS 304



### 29 CONCEALED HINGE - 3D & 2D



Models-CH3D-40/CH3D-80/CH3D-120/CH2D-80WD

## FLOOR SPRING & ACCESSORIES



### FLOOR SPRING - 84

- 10,00,000 cycle tested
- Universal Application - Load Adjustment From: 80kg -100kg (For DFS 84-100C model) and 100kg - 130kg (For DFS 84-130C model)
- Max. Door Width: 1000mm (For DFS 84-100) and 1100mm (For DFS 84-130).
- Max. Opening Angle - 130°
- 90° Hold Open Angle



DFS 84-100C



DFS 84-130C



### FLOOR SPRING - 75V

- 5,00,000 cycles tested
- Universal application - Load adjustment from 60 kg to 150 kg
- Door Width - 600 - 1100mm
- Max opening angle - 360°
- Hold Open function at any point between 90° to 105° and -90° to -105°



#### 30 FLOOR SPRING - 60



#### 31 FLOOR SPRING - 90



#### 32 FLOOR SPRING - 250



#### FLOOR SPRING DOOR ACCESSORIES DFS-A1



#### FLOOR SPRING DOOR ACCESSORIES DFS-A2



**30** - 5,00,000 cycle tested. Max. open angle : 116°. Hold open angle: 90° Max. Door Width : 700mm. Max. Door Weight: 60 kgs. **31** - 5,00,000 cycle tested. Max. open angle : 116°. Max. open angle: 90° Max. Door Width : 1000mm. Max. Door Weight : 90 kgs. **32** - 5,00,000 cycle tested. Door Width : 1200mm. Max. open angle : 130°. Hold open angle: 90° **33** - To be used directly on the floor without floor spring. **34** - Top receiver pivot for wooden or ceiling installation.

#### 33

#### BOTTOM PIVOT



#### 34

#### TOP PIVOT





# WINDOW, DOOR & GLASS HARDWARE

## DOOR CLOSERS



**37** DOOR CLOSER - DC 301  
DOOR CLOSER - DC 301-B



**38** DOOR CLOSER - PELMET ARM

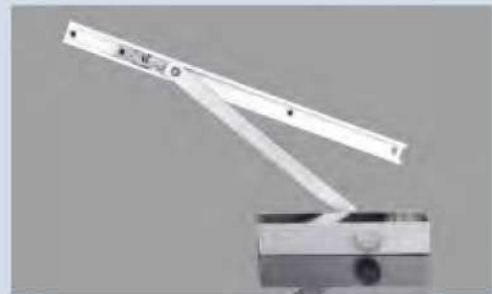

**35** DOOR CLOSER - DC 101  
DOOR CLOSER - DC 101-B



**36** DOOR CLOSER - DC 201  
DOOR CLOSER - DC 201-B  
DOOR CLOSER - DC 201-C

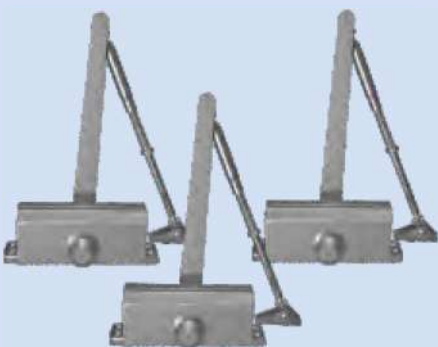

DC 201-C



**39** DOOR CLOSER - DC 1001



**40** DOOR CLOSER - DC 1002



**35** - DC 101 Door Width : 600-850 mm. Door Weight : 65 kgs. Type : Hold Open. Opening Angle : 180°. DC 101-B Door Width : 600-800 mm. Door Weight : 45 kgs. Type : Without Hold Open. Opening Angle : 180°. **36** - DC 201 Door Width : 800-1050mm. Door Weight : 85 kgs. Type : Hold Open. Opening Angle : 180°. DC 201-B Door Width : 600-900mm. Door Weight : 65 kgs. Type : Without Hold Open. Opening Angle : 180°. DC 201-C Door Width : 1050mm. Door Weight : 85 kgs. Type : Without Hold Open. Opening Angle : 180°. **37** - DC 301 Door Width : 900-1200mm. Door Weight : 105 kgs. Type : Hold Open. Opening Angle : 180°. DC 301-B Door Width : 1200mm. Door Weight : 105 kgs. Type : Without Hold Open. Opening Angle : 180°. **38** - Door Width : 500 - 1000mm. Door Load Capacity: 30 - 80 kgs. Type : Hold Open. Opening Angle : 130°. 3,00,000 cycle tested. **39** - Door Width : Up to 850mm. Door Weight : 65 kgs. Type : Hold Open. Opening Angle : 180°. **40** - Door Width : Up to 1000mm. Door Weight : 85 kgs. Type : Hold Open. Opening Angle : 150°.





### GLASS SLIDING FOLDING FITTINGS (SS 304)

Finish: Brushed Steel  
Size: 10mm to 12mm Glass

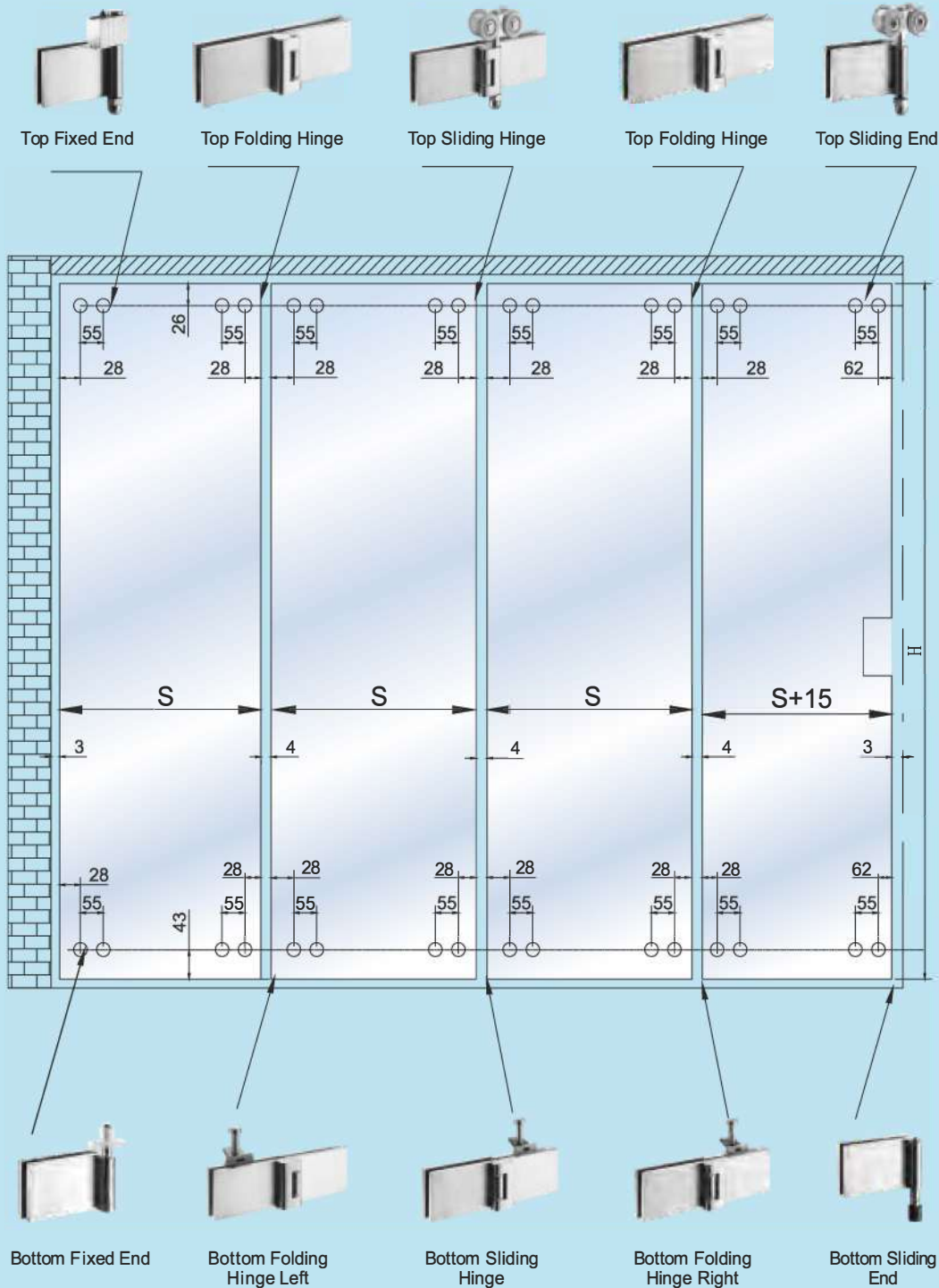

### GLASS CONNECTORS (SS 304)

Glass Thickness: 8 - 12mm

90° WALL TO GLASS OR FLOOR TO GLASS CONNECTOR



90° WALL TO GLASS CONNECTOR



90° GLASS TO GLASS CONNECTOR



135° WALL TO GLASS CONNECTOR



135° GLASS TO GLASS CONNECTOR



180° WALL TO GLASS CONNECTOR



180° GLASS TO GLASS CONNECTOR



3 WAY GLASS TO GLASS CONNECTOR





# WINDOW, DOOR & GLASS HARDWARE

## PATCH FITTINGS (SS 304)

Glass Thickness: 8 - 12mm  
Finish: Brushed Steel

### BOTTOM CORNER PATCH

DPF1-01



### TOP CORNER PATCH

DPF1-02



### CORNER 'L' PATCH WITH PIVOT

DPF1-04



### CENTRE LOCK

DPF2-01



### STRIKE PATCH FOR CENTRE LOCK

DPF2-02



### SINGLE CONNECTOR PATCH

DPF3-01



### CORNER 'L' PATCH WITHOUT PIVOT

DPF3-02



## PATCH FITTINGS

Finish: Brushed Steel

### OVER PANEL PATCH WITH PLATE

DPF1-03



### QUAD CONNECTOR PATCH

DPF3-03



### DOUBLE CORNER PATCH

DPF3-04



### AUTO CLOSING PATCH

DACP1-100



## GLASS DOOR LOCKS (SS 304)

Finish: Brushed Steel  
Glass Thickness: 10mm -12mm

### OPENABLE GLASS DOOR LOCK - GLASS TO WOOD - SS304



### OPENABLE GLASS DOOR LOCK - GLASS TO GLASS - SS304



## OPENABLE GLASS DOOR LOCK - GLASS TO GLASS - SS304 - KNOB



### SLIDING GLASS DOOR LOCK - GLASS TO WOOD - SS304



### SLIDING GLASS DOOR LOCK - GLASS TO GLASS - SS304



## SHOWER HINGES (SS 304)

Glass Thickness: 8 - 12mm  
Max. Load: 54kgs.  
Finish: Brushed Steel/ Polished SS

### SHOWER HINGE 90° (WALL TO GLASS) - T TYPE



### SHOWER HINGE 90° (WALL TO GLASS) - L TYPE



### SHOWER HINGE 135° GLASS TO GLASS



## SHOWER HINGE 180° GLASS TO GLASS



## SHOWER HINGE 90° GLASS TO GLASS



## GLASS DOOR HANDLES (SS 304)

Finish: Brushed Steel

### 41 DOOR HANDLE - D



### 42 DOOR HANDLE - H



41 Sizes	Hole to hole
ØDia(mm)	ØDistance(mm)

Ø19mm	X 250mm
Ø22mm	X 300mm
Ø25mm	X 450mm
Ø32mm	X 600mm

42 Sizes	Hole to hole
ØDia(mm)	ØDistance(mm)

Ø22mm	X 150mm
Ø25mm	X 200mm
Ø25mm	X 300mm
Ø32mm	X 450mm
Ø32mm	X 750mm

**SHOWER FITTINGS** Finish: Brushed Steel/SSS/ Polished SS

**WALL TO TUBE CONNECTOR - 19MM**



**TUBE TO GLASS CONNECTOR - 19MM**



**TUBE TO TUBE CONNECTOR - 19MM**



**SHOWER ROD Ø 32 X 24**



**SHOWER DOOR KNOB**



**DOOR HANDLE - DIA 19MM X 150MM X 450MM**



**DOOR STOPPER**



**PLASTIC SEALS**

**43**

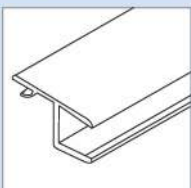

**PVC SEAL**  
BPS1-10

**44**

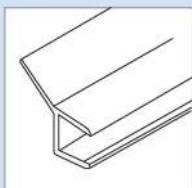

**PVC SEAL**  
BPS2-08/10/12mm

**45**

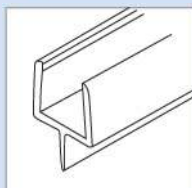

**BOTTOM PVC SEAL**  
BPS3-08/10/12mm

**46**

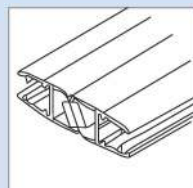

**180° MAGNETIC SEAL**  
BPS6-M08/M10/M12mm

**47**

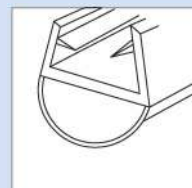

**PVC SEAL**  
BPS7-S08/S10/S12mm

**48**

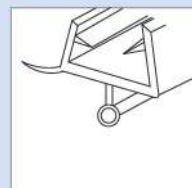

**PVC SEAL**  
BPS8-D08/D10

**SHOWER SLIDING FITTINGS - RECTANGULAR**

- Made out of SS304
- Max. load - 60kgs.
- Suitable for 8mm to 10mm glass thickness .
- Max. installation length 2 mtrs.
- Glass to be toughened after making the holes.

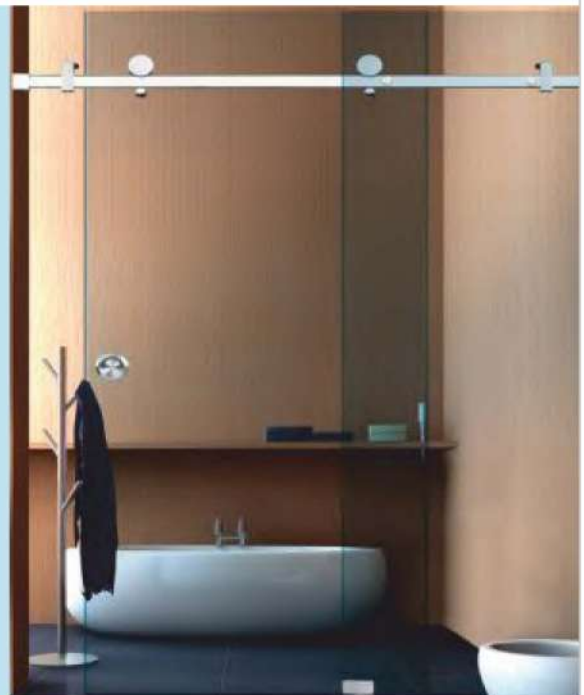

**SLIDING GLASS DOOR HANDLE**

**49** SLIDING GLASS DOOR HANDLE - SS304



SGD1 BS/PS

**50** SLIDING GLASS DOOR HANDLE - ALUMINIUM



SGD2 AP



SGD3 AP

- 43** - BPS1-10mm. Glass Thickness: 10mm.
- 44** - BPS2-08/10/12mm. Glass Thickness: 8mm - 12mm.
- 45** - BPS3-08/10/12mm. Glass Thickness: 8mm -12mm.
- 46** - BPS6-M08/M10/M12. Glass Thickness: 8mm -12mm.
- 47** - BPS7-S08/S10/S12. Glass Thickness: 8mm -12mm.
- 48** - BPS8-D08/D10. Glass Thickness: 8mm -10mm.
- 49** - Glass Thickness: 8mm -12mm. Finish: Brushed Steel/Polished SS.
- 50** - Glass Thickness: 8mm - 12mm. Finish: Aluminium Polished.