



Simplifying *lives.*

POLE SHELVING SYSTEMS & ACCESSORIES

Space Creating Solutions!





Space saving is out. Space creation is in. With Livsmart Pole Shelving Systems, create the perfect combination of closed and open storage and shelving to suit individual needs with a wide choice of fittings that will make your living room, bedroom and even your retail store look more open and spacious!

With a wide variety of durable and aesthetically designed units, there is no limit to the permutations and combinations in which space can be created!

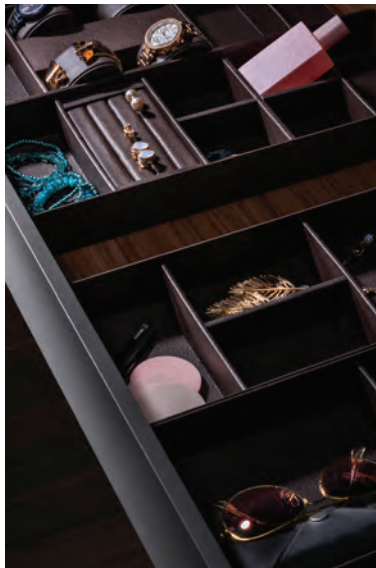

CONTENTS

1. INTRODUCTION 4
2. POLE SHELVING SYSTEM - COMPONENTS 6
3. LIVING ROOM APPLICATION 11
4. STUDY / WORK FROM HOME APPLICATION 13
5. WALK-IN WARDROBE APPLICATION 15
6. BEDROOM APPLICATION 16
7. BATHROOM APPLICATION 17
8. RETAIL APPLICATION 19
9. HI SLIDE WALK-IN SLIDING SYSTEM 20
10. WARDROBE ACCESSORIES 24
11. FURNITURE LIGHTS LED - 24V 30

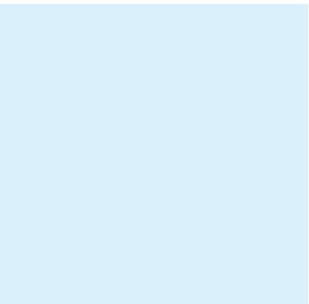

INTRODUCTION

A sophisticated shelving system minimal by design, versatile and exceptionally flexible. Wide range of adaptors, brackets, shelves, cabinets, hangers and Pullout drawers makes it a designer's choice due to its functionality. These can be mounted from floor to ceiling or floor to wall as high up to 3 meters.

Thoughtfully designed aluminium section for concealed wires that enables the addition of light fixtures, television sets, music systems, desktop, computers and other devices that need electric power on the pole shelving units.

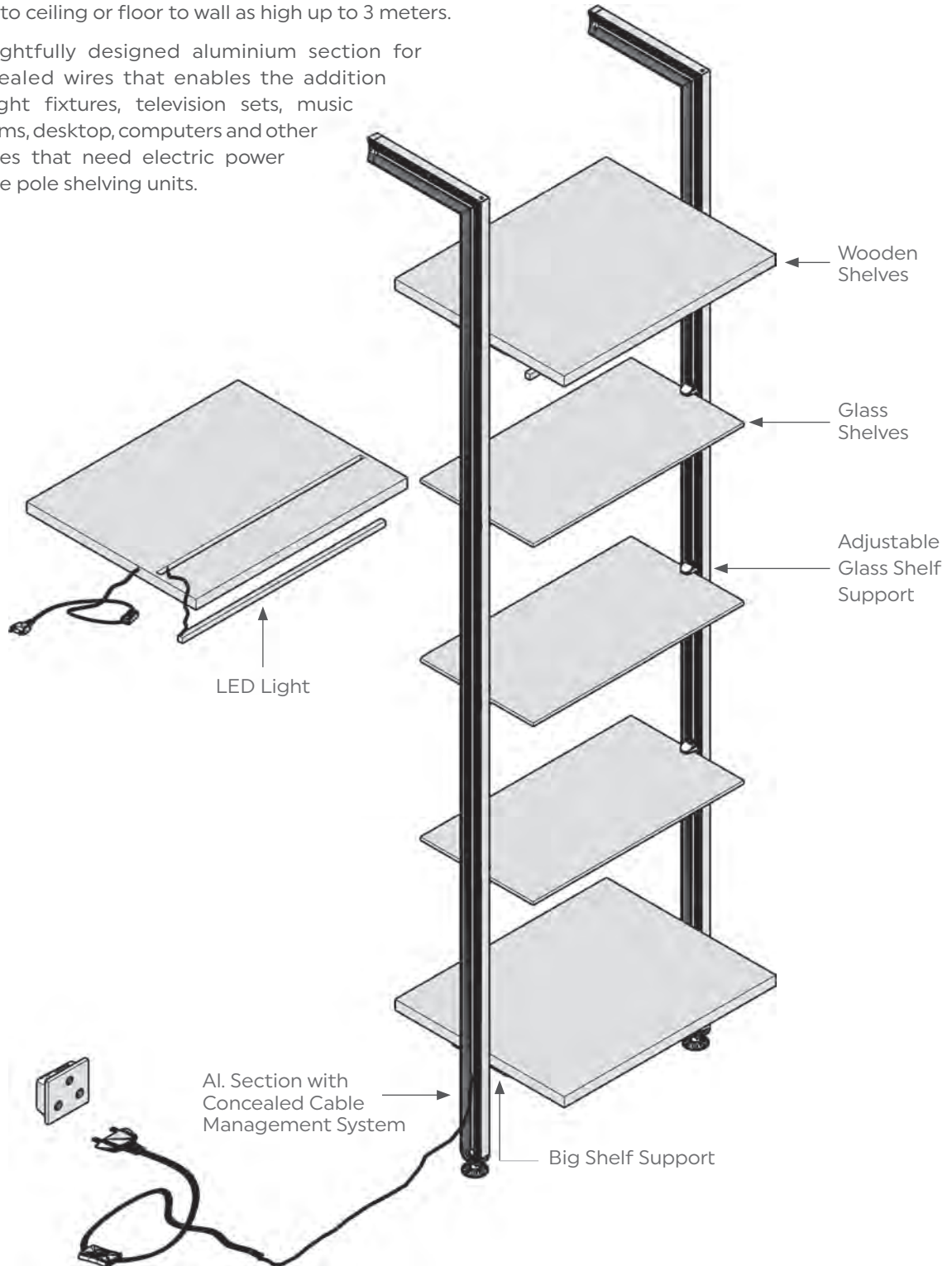

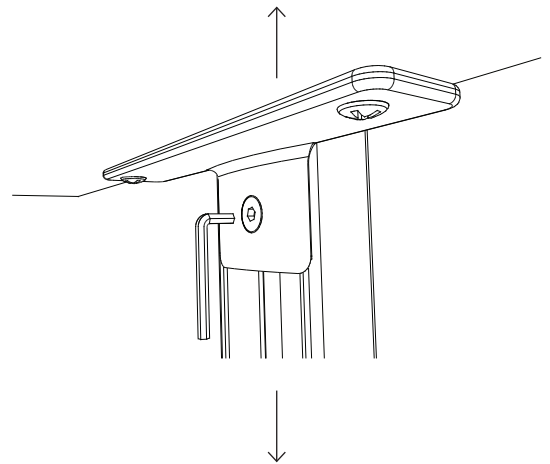
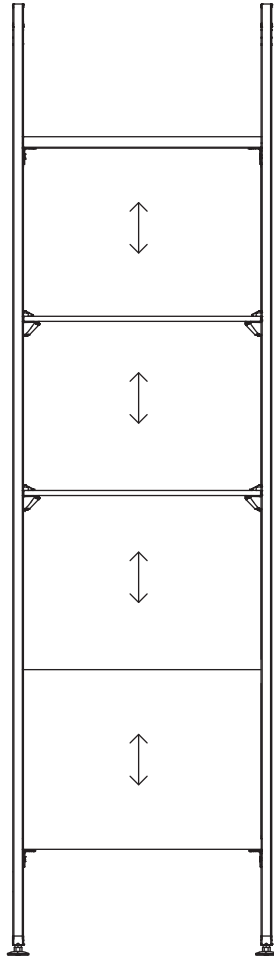
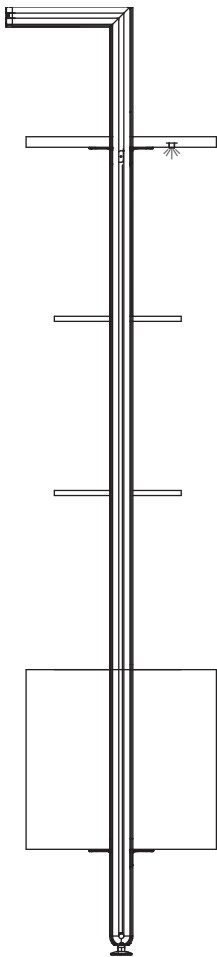

Design your own unit by imaginatively using Ebco's Pole Shelving Systems! There's no limit to what you can create!

POLE SHELVING SYSTEM - COMPONENTS

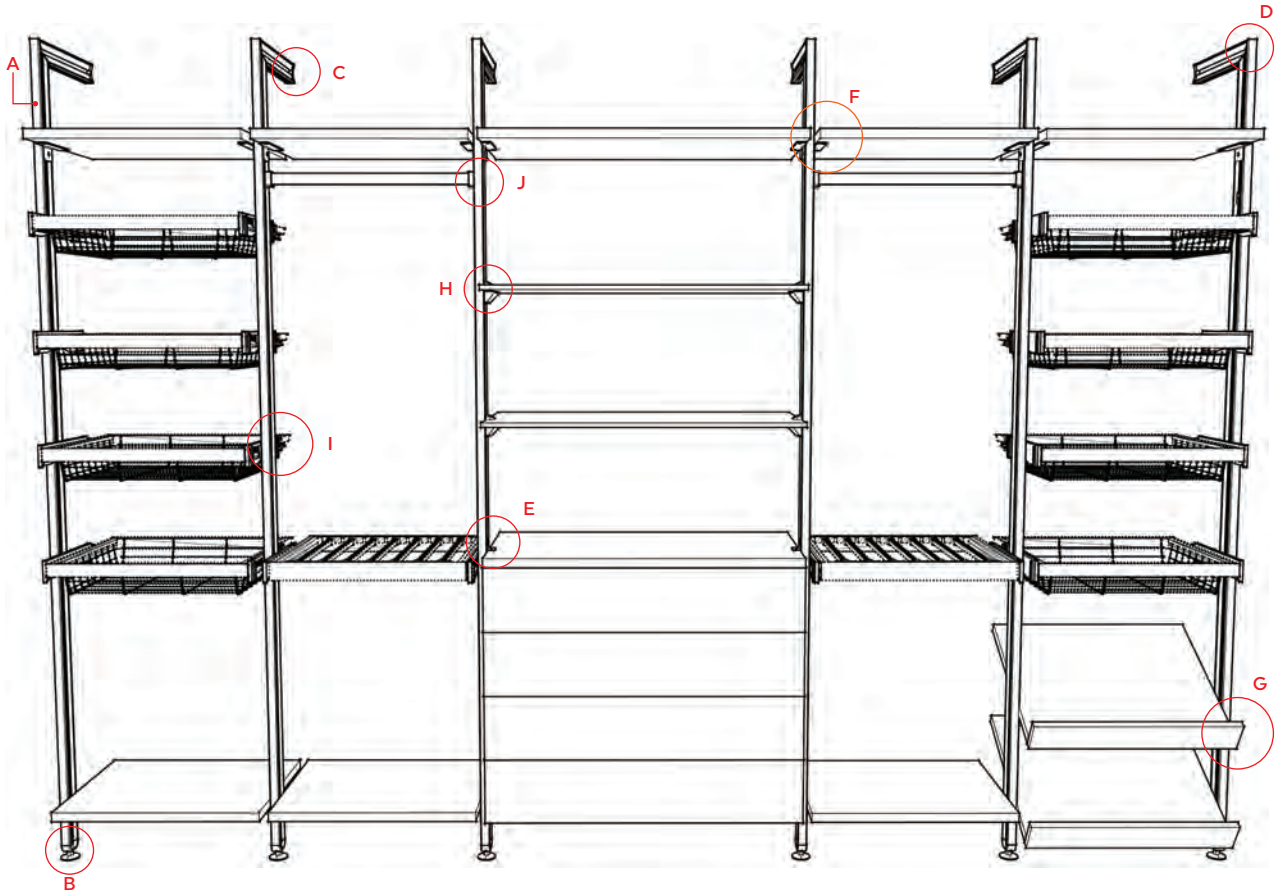

A
Aluminium Section

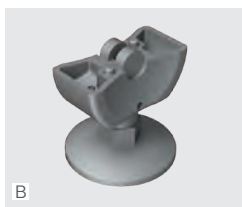

B
Height Adjustable Plinth



C
End Connector Set



D
Right Angle Connector



E
Small Shelf Support



F
Big Shelf Support



G
Tilting Shelf Bracket



H
Adjustable Glass Shelf Support

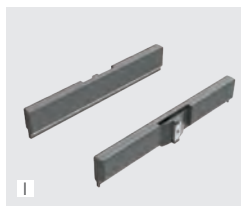

I
Concealed Slide Adaptors



J
Rectangular Rail Support

POLE SHELVING COMPONENTS

Aluminium Section

CODE: PPDS - ALS, FINISH: ANODISED BROWN / ANODISED SILVER

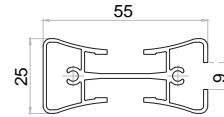

Height Adjustable Plinth

CODE: PPDS - HAP, FINISH: BROWN / SILVER

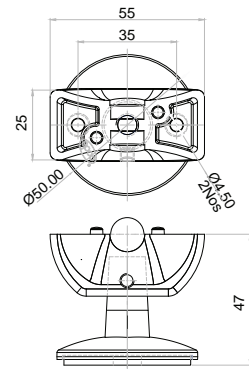
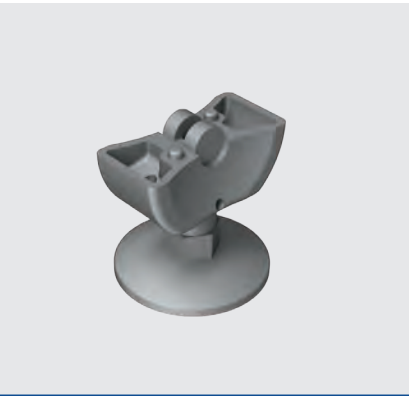

End Connector Set

CODE: PPDS - ECS, FINISH: BROWN / SILVER

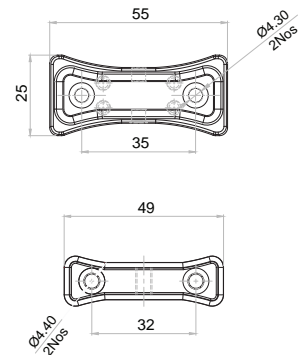

POLE SHELVING COMPONENTS

Right Angle Connector

CODE: PPDS-RAC, FINISH: BROWN / SILVER

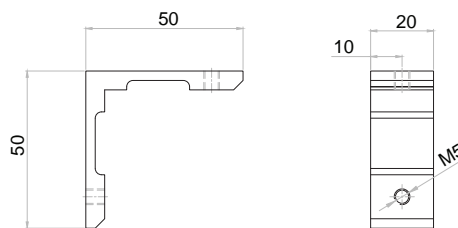
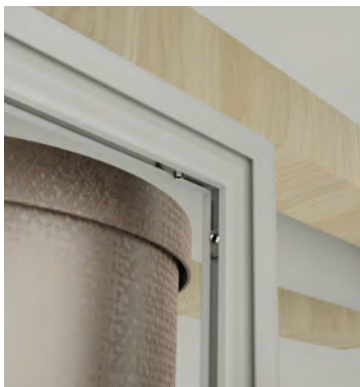

Small Shelf Support

CODE: PPDS - SSS, FINISH: BROWN / SILVER

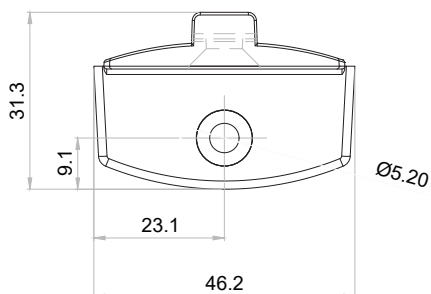

Big Shelf Support

CODE: PPDS - BSS, FINISH: BROWN / SILVER

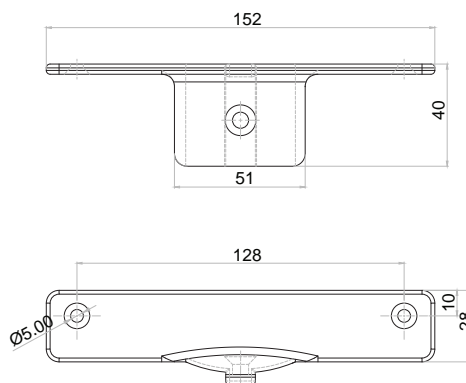



LIVING ROOM APPLICATION



Aluminium Section

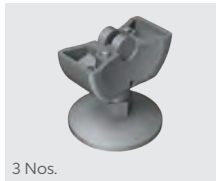

3 Nos.
Height Adjustable Plinth



3 Nos.
End Connector Set



3 Nos.
Right Angle Connector



10 Set
Big Shelf Support

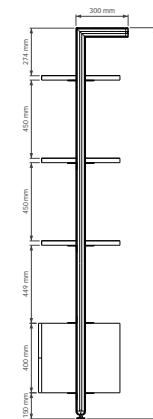
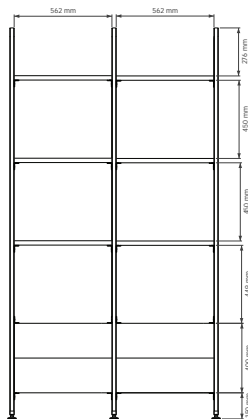
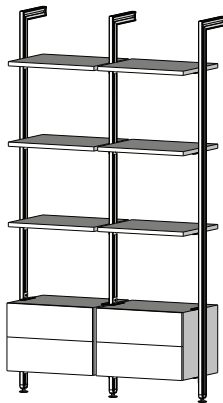

LIVING ROOM APPLICATION



Aluminium Section

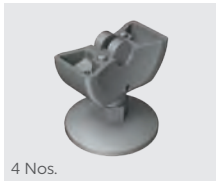

4 Nos. Height Adjustable Plinth



4 Nos. End Connector Set



4 Nos. Right Angle Connector



14 Set Big Shelf Support

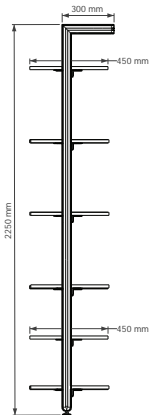
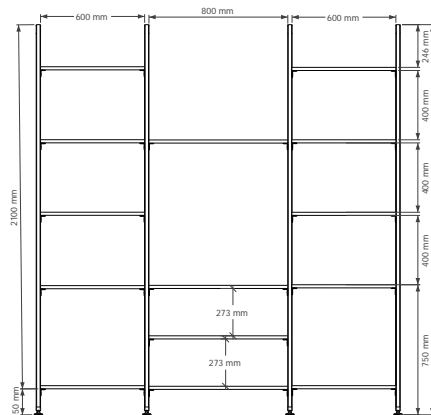

STUDY / WORK FROM HOME APPLICATION



Aluminium Section



3 Nos.

Height Adjustable Plinth



3 Nos.

End Connector Set



3 Nos.

Right Angle Connector



7 Set

Big Shelf Support



2 Set

Small Shelf Support

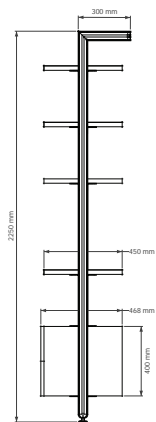
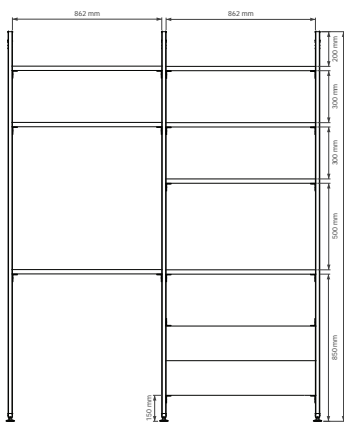
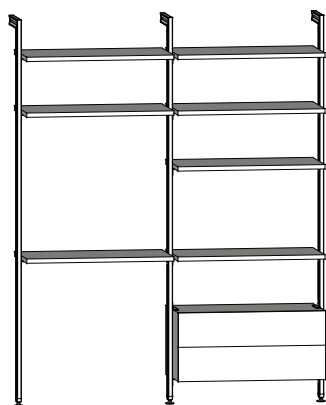

STUDY / WORK FROM HOME APPLICATION

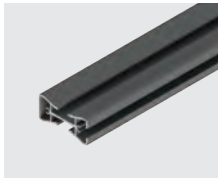

Aluminium Section



6 Nos.

Height Adjustable Plinth



6 Nos.

End Connector Set



6 Nos.

Right Angle Connector



17 Set

Big Shelf Support



6 Set

Adjustable Glass Shelf Support

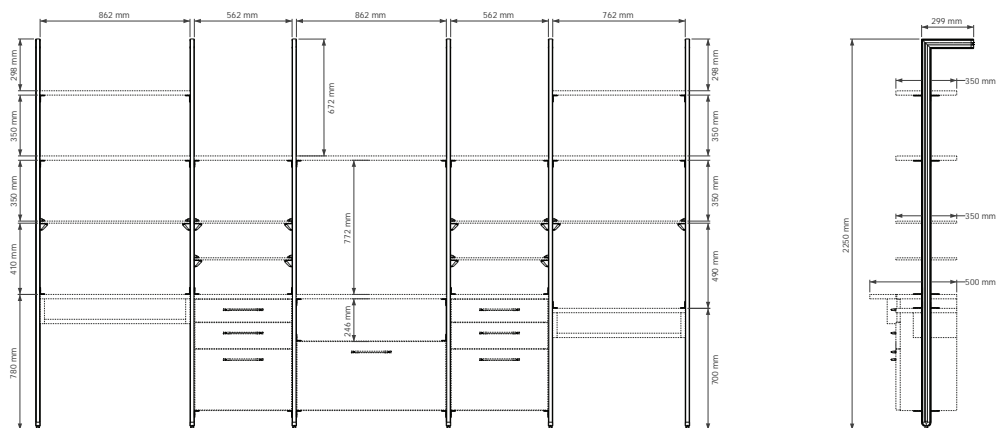

WALK-IN WARDROBE APPLICATION



Aluminium Section



10 Nos.
Height Adjustable
Plinth



10 Nos.
End Connector Set



10 Nos.
Right Angle
Connector



25 Set
Big Shelf Support



4 Set
Adjustable Glass
Shelf Support



7 Set
Concealed Slide
Adaptors



3 Set
Rectangular Rail
Support

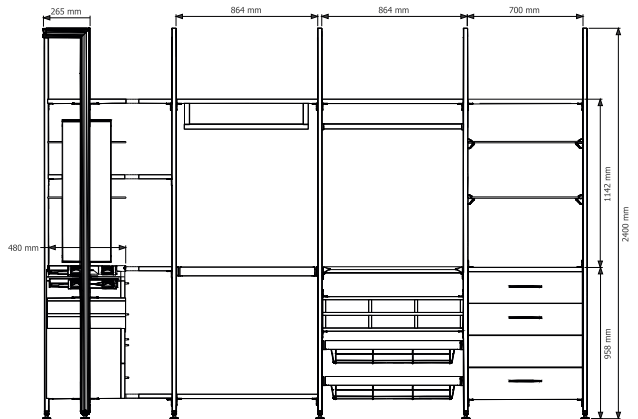
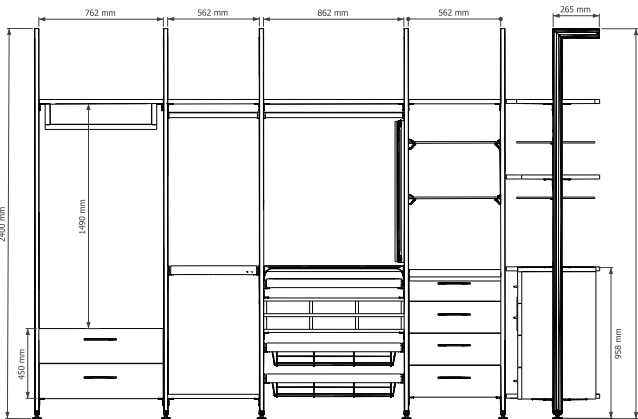

BEDROOM APPLICATION

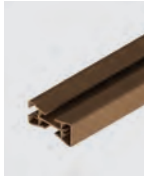

Aluminium Section



6 Nos.
Height Adjustable Plinth



6 Nos.
End Connector Set



6 Nos.
Right Angle Connector



11 Set
Big Shelf Support



2 Set
Tilting Shelf Bracket



2 Set
Adjustable Glass Shelf Support



8 Set
Concealed Slide Adaptors



2 Set
Rectangular Rail Support

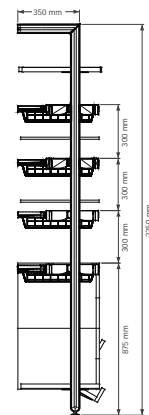
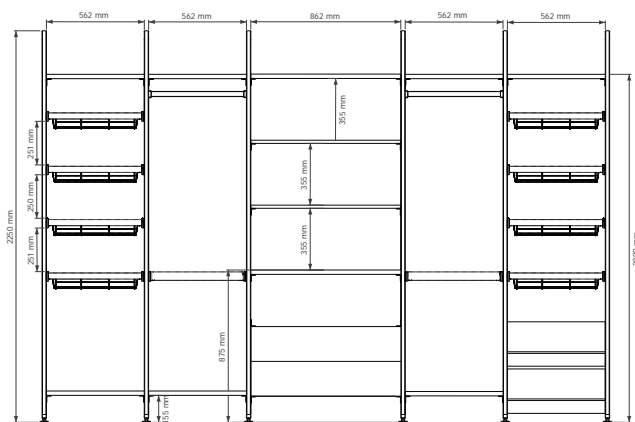

BATHROOM APPLICATION



Aluminium Section

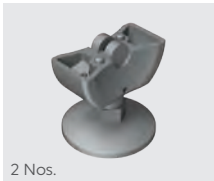

2 Nos.

Height Adjustable Plinth



2 Nos.

End Connector Set



2 Nos.

Right Angle Connector



2 Set

Big Shelf Support



3 Set

Adjustable Glass Shelf Support

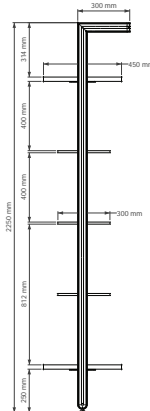
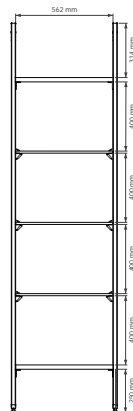
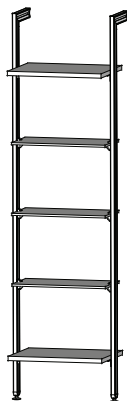

BATHROOM APPLICATION

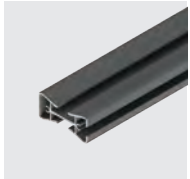

Aluminium Section



3 Nos.
Height Adjustable
Plinth



3 Nos.
End Connector Set



3 Nos.
Right Angle
Connector



5 Set
Big Shelf Support



6 Set
Adjustable Glass
Shelf Support



1 Set
Rectangular Rail
Bracket

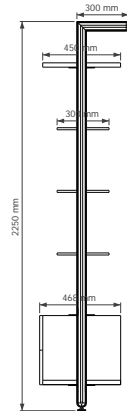
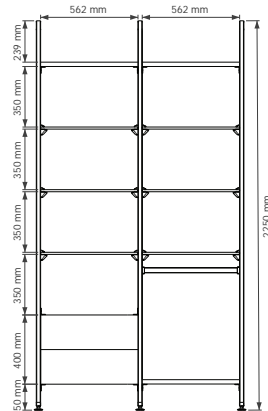
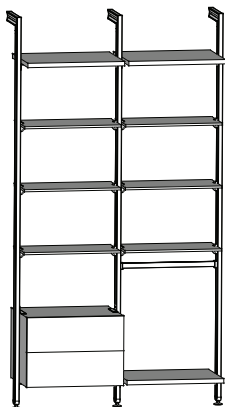

RETAIL APPLICATION

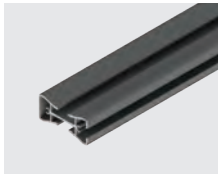

Aluminium Section



4 Nos.

Height Adjustable Plinth



4 Nos.

End Connector Set



4 Nos.

Right Angle Connector



4 Set

Big Shelf Support



7 Set

Tilting Shelf Bracket

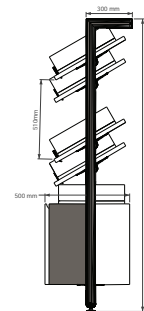
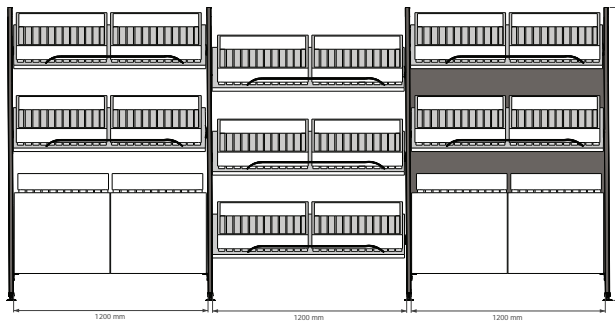



HI SLIDE WALK-IN SLIDING SYSTEM

Get a walk-in wardrobe with Ebco's Pole Shelving System! Light yet strong, these systems have a unique design and functionality, allowing you to create additional space and storage, with easy and quick installation. With a choice of open and closed fittings and units, you can custom fit your bedroom with the perfect wardrobe!

FEATURES :

- Floor to ceiling sliding system which are light (to use build 9mm panels), effortless silent sliding has soft close, soft open feature.
- Modular and highly flexible in terms of design, to use multiple panels of wood or glass to suit the décor.
- Superior design with 2 way soft close ensures high strength & smooth functioning.
- Quick & hassle free installation.
- Available in 6 different colour profiles.

HI SLIDE WALK-IN SLIDING SYSTEM

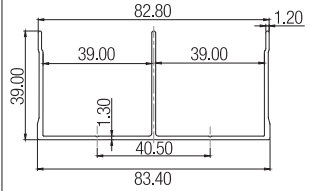
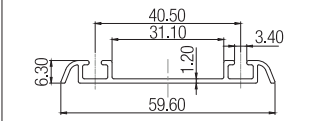
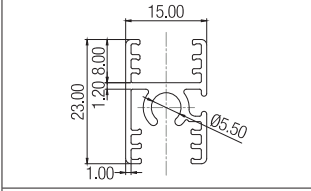
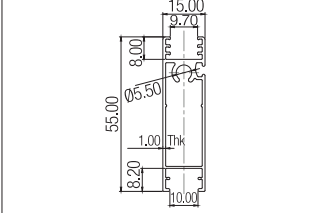
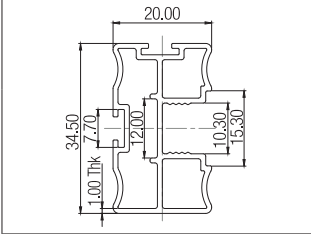
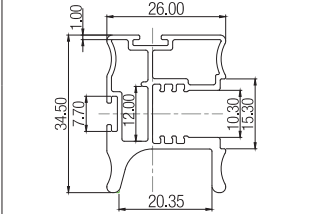
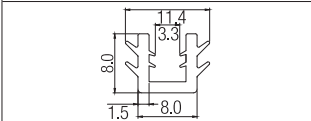
PRODUCT	ITEM	CODE	FINISH	PCS/ SET
	Bottom Roller Fitting (for single door)	HSWSS-BR1	NP	Set of 2
	2 Way Soft Close Damper-15 Kgs (single door kit with actuator)	HSWSS-SCK-15	GR	Set of 2
	2 Way Soft Close Damper-25 Kgs (single door kit with actuator)	HSWSS-SCK-25	GR	Set of 2
	2 Way Soft Close Damper-40 Kgs (single door kit with actuator)	HSWSS-SCK-40	GR	Set of 2
	Top GuidingTrack	HSWSS-TGT-3M	AS/BL/SF/CP/BA/CH	3m
	Bottom Roller Track	HSWSS-BRT-3M	AS/BL/SF/CP/BA/CH	3m
	Shutter Profile-Top/Mid	HSWSS-SPTM-3M	AS/BL/SF/CP/BA/CH	3m
	Shutter Profile-Bottom	HSWSS-SPB-3M	AS/BL/SF/CP/BA/CH	3m
	Shutter Profile-Vertical	HSWSS-SPV-3M	AS/BL/SF/CP/BA/CH	3m
		HSWSS-SPV-36	AS/BL/SF/CP/BA	3.66m
	Shutter Profile-Vertical Handle	HSWSS-SPVH-3M	AS/BL/SF/CP/BA/CH	3m
		HSWSS-SPVH-36	AS/BL/SF/CP/BA	3.66m
	Sleeve for Hi Slide Walk-in Wardrobe 4 mm Glass (optional)	HSWSS-SL4	CL	3m

HI SLIDE WALK-IN SLIDING SYSTEM

Wooden Door Application

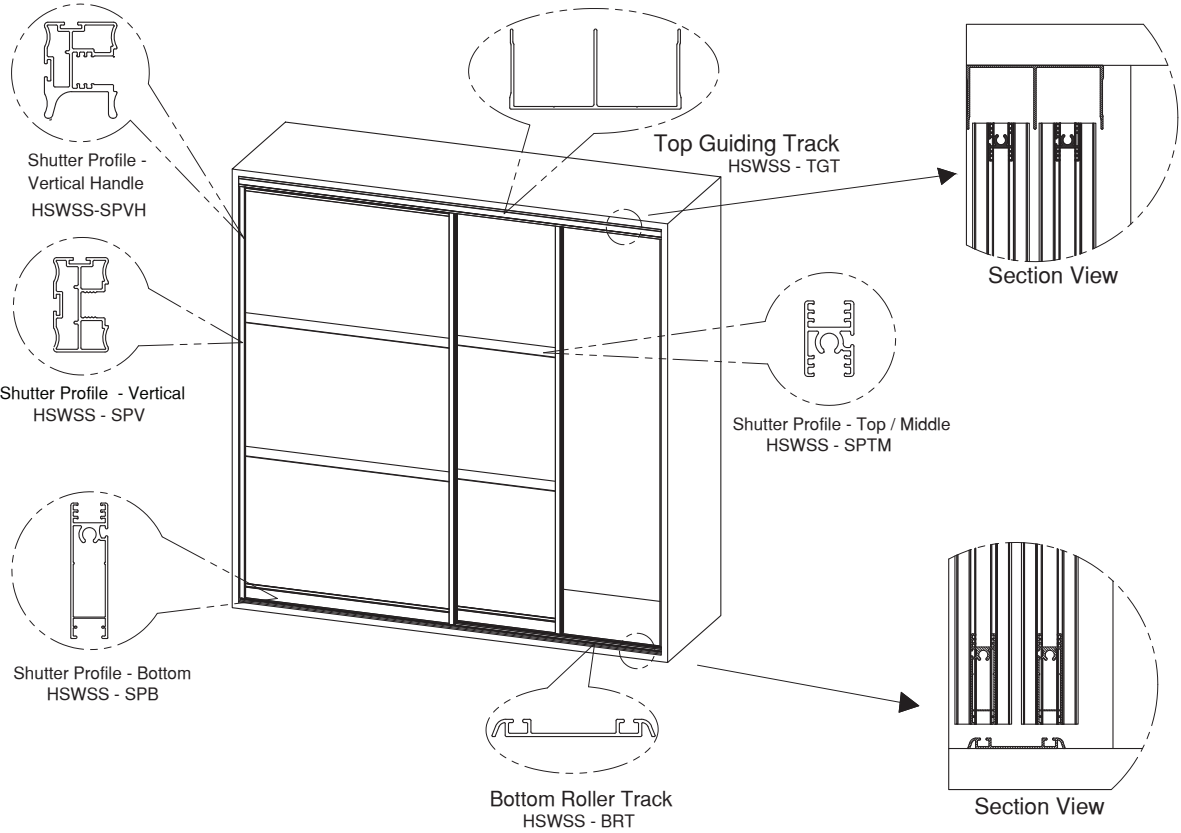

HSWSS Shutter Size Calculation

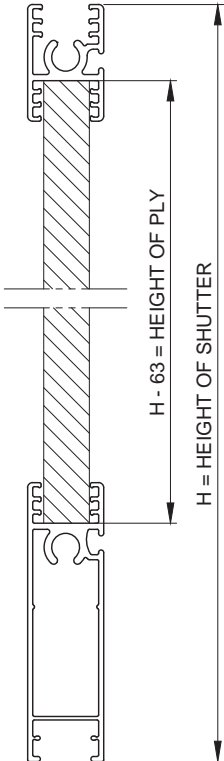
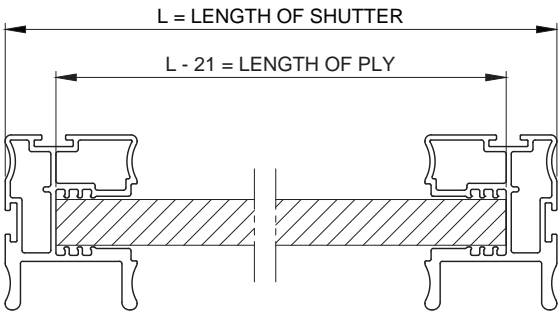

HI SLIDE WALK-IN SLIDING SYSTEM

Glass Door Application

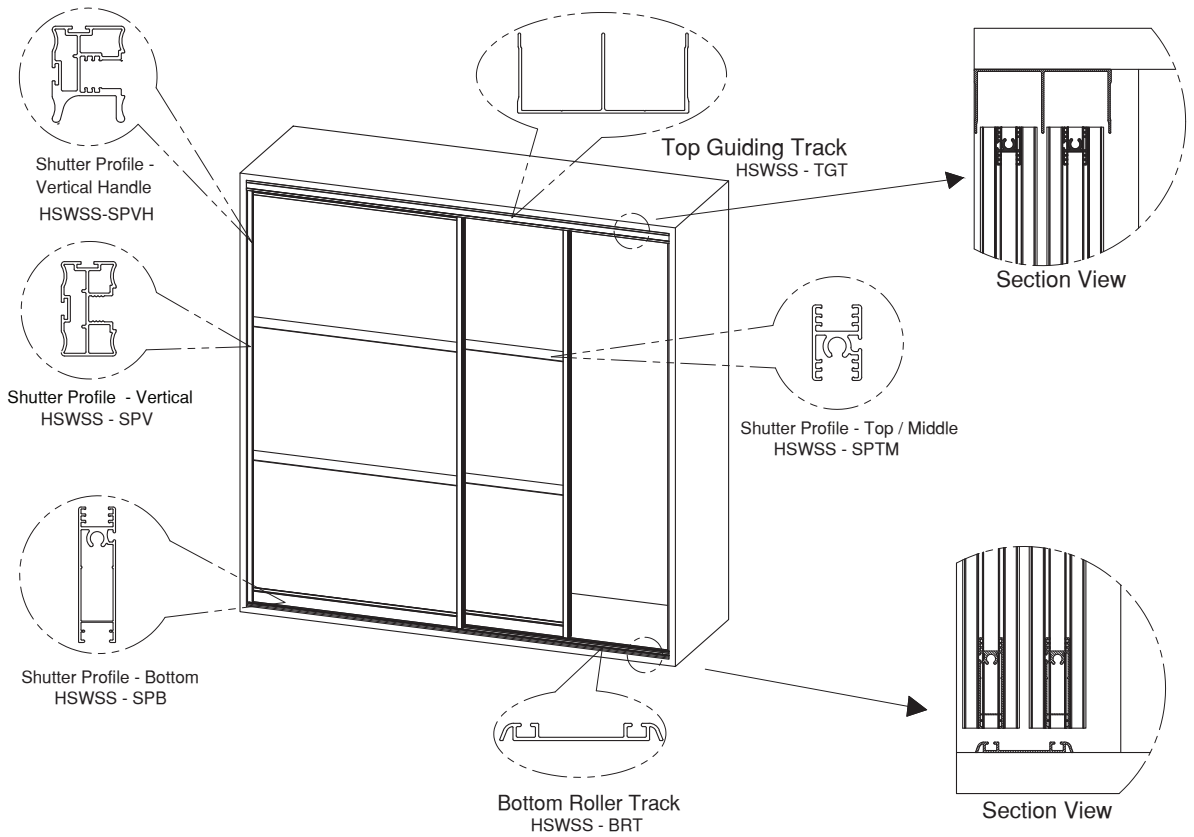

HSWSS Shutter Size Calculation

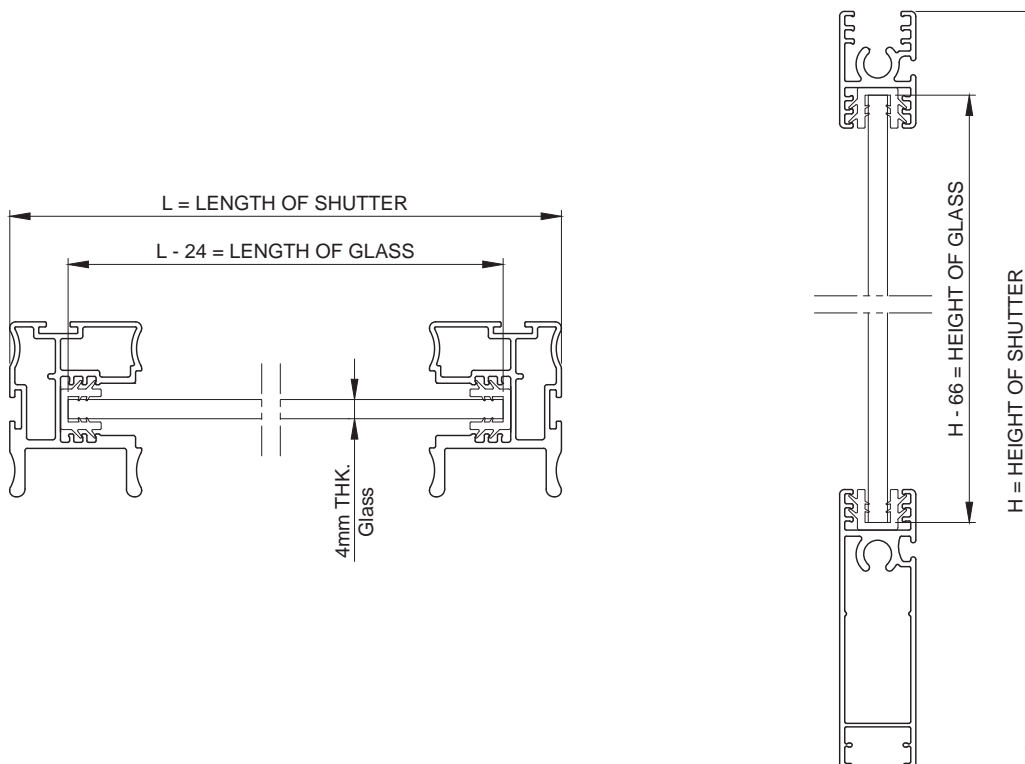



WARDROBE ACCESSORIES

Ebco's wide range of wardrobe pullout accessories give clear overview of every item stored in your wardrobes. Dresses, Shoes, Trousers, Jewellery or any other accessories - choose the right solution to store all your favourite items carefully and in a stylish way.

WARDROBE ACCESSORIES

Wardrobe Pullout - Trouser / Saree (Soft Close)

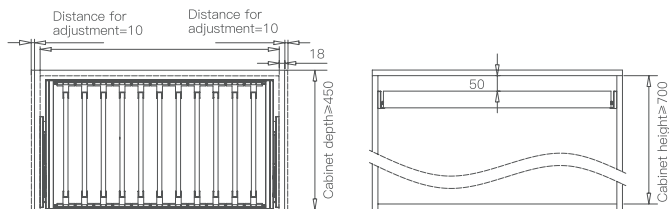

Wardrobe Pullout Drawer Organiser (Soft Close)

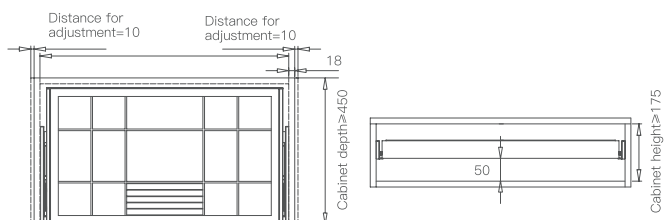

Wardrobe Pullout Basket (Soft Close)

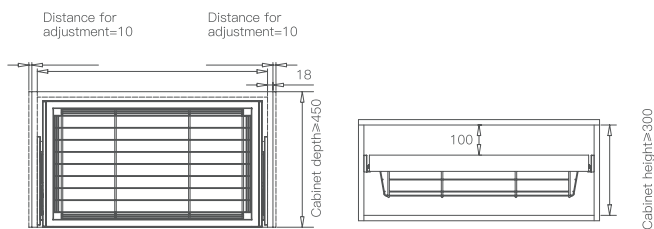

SR.NO	ITEM	CODE	SIZE (MM)	FINISH
1	Wardrobe Pullout - Trouser / Saree (Soft Close)	WPTS-45-SC-BR	414 X 470 X 140	Brown
		WPTS-60-SC-BR	564 X 470 X 56	
		WPTS-90-SC-BR	864 X 470 X 56	
	Extra Hanger for WPTS	WPTS-EH4	L=470	
2	Wardrobe Pullout Drawer Organiser (Soft Close)	WPDO-45-SC-BR	414 X 470 X 140	Brown
		WPDO-60-SC-BR	564 X 470 X 140	
		WPDO-90-SC-BR	864 X 470 X 140	
3	Wardrobe Pullout Basket (Soft Close)	WPB-45-SC-BR	414 X 470 X 140	Brown
		WPB-60-SC-BR	564 X 470 X 140	
		WPB-90-SC-BR	864 X 470 X 140	

WARDROBE ACCESSORIES

Wardrobe Pullout Basket - Wicker (Soft Close)

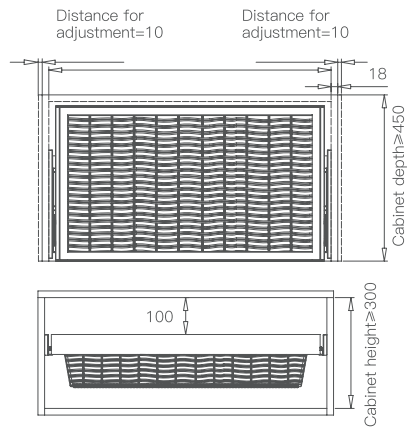

Wardrobe Pullout Shoe Rack - Soft Close

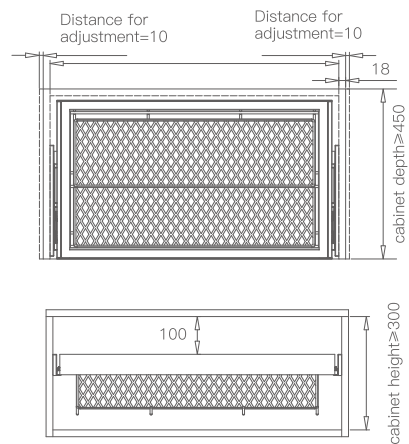

SR.NO	ITEM	CODE	SIZE (MM)	FINISH
1	Wardrobe Pullout Basket - Wicker (Soft Close)	WPBW-45 SC BR	414 X 470 X 140	Brown
		WPBW-60 SC BR	564 X 470 X 140	
		WPBW-90 SC BR	864 X 470 X 140	
2	Wardrobe Pullout Shoe Rack	WPSR-60-SC-BR	564 X 470 X 56	Brown
		WPSR-90-SC-BR	864 X 470 X 56	

WARDROBE ACCESSORIES

Wardrobe Drawer Organiser 2



FEATURES:

- Rearrange your valuables as desired with these multipurpose divider organisers.
- Can be easily added to a finished wardrobe and moved around to suit your needs.
- Ideal for storing multiple items such as jewellery, watches, bangles or other accessories.
- Dimension : Length(425mm), Width(165mm), Height (50mm)



WDO2-WB1

WDO2-M41

WDO2-OR

WDO2-M42

WDO2-WB2

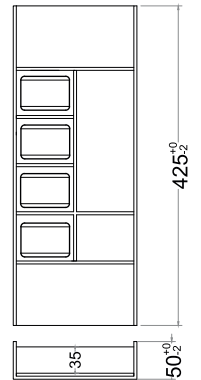
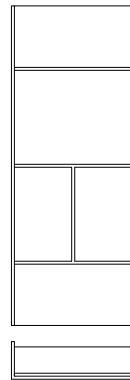
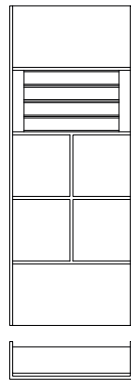
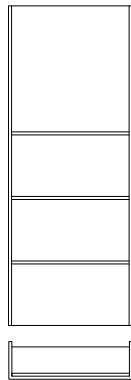
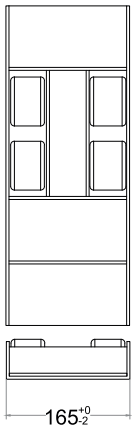

SR.NO	ITEM	CODE	SIZE (MM)	FINISH
1	Wardrobe Drawer Organiser 2 - Watch / Bangles 1	WDO2-WB1	425 X 165 X 50	Brown
	Wardrobe Drawer Organiser 2 - Watch / Bangles 2	WDO2-WB2		
	Wardrobe Drawer Organiser 2 - Multipurpose-4-1	WDO2-M41		
	Wardrobe Drawer Organiser 2 - Multipurpose-4-2	WDO2-M42		
	Wardrobe Drawer Organiser 2 - Ornaments & Rings	WDO2-OR		

WARDROBE ACCESSORIES

Wardrobe Rail Fittings - Rectangular Rail & Bracket

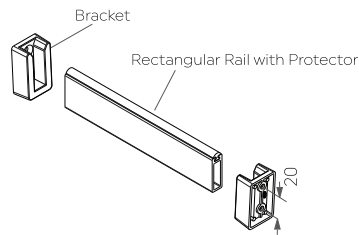

ITEM	CODE	SIZE (MM)	FINISH
Wardrobe Rail Fitting - Rectangular Rail	WRF-RR-2-AN	10 X 30	Anodised Brown
	WRF-RR-3-AN	10 X 30	
	WRF-RR-3M-AN	10 X 30	
	WRF-RR-2-BA	10 X 30	Brushed Aluminium
	WRF-RR-3M-BA	10 X 30	
	WRF-RR-3-BA	10 X 30	
Wardrobe Rail Fitting Rectangular Bracket	WRF - BR1	42 X 25 X Ø 4	Brown / Anodized Champagne

L Connector for Rectangular Al. Rail

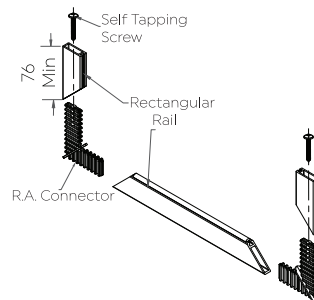

ITEM	CODE	SIZE (MM)	FINISH
L Connector for Rectangular Al. Rail	WRF - RRC	-	Brown

Wardrobe Rail Fittings - Oval

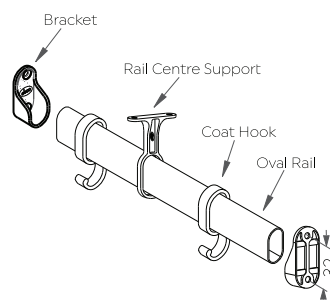
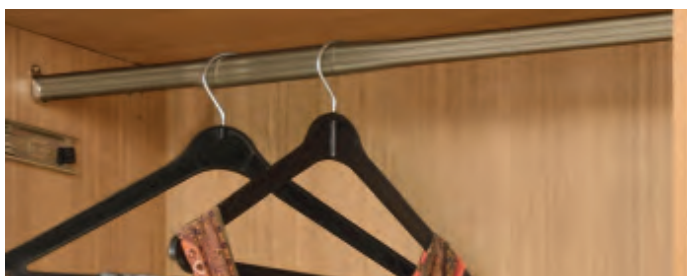

ITEM	CODE	SIZE (MM)	FINISH
Wardrobe Rail Fittings - Oval	WRF RA 1 AC / CP	-	Anodised Champagne / Chrome Plated
	WRF RA 2 AC / CP	-	
	WRF RA 3 AC / CP	-	
Bracket	WRF-B1	-	Nickel Plated
Bracket - MS	WRF-B2	-	
Rail Centre Support	WRF-RS1	-	Nickel Plated
Coat Hook	WRF - CH	-	Black/Grey

WARDROBE ACCESSORIES

Wardrobe Rail R.A Connector

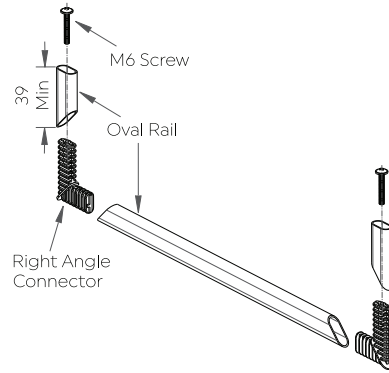

ITEM	CODE	SIZE (MM)	FINISH
Wardrobe Rail R.A. Connector	WRF-RAC	-	Brown

Mirror Pullout (Frameless)

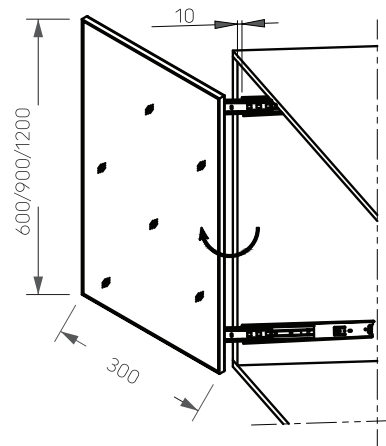

ITEM	CODE	SIZE (MM)	FINISH
Mirror Pullout (Frameless)	WA-POM60 N	600 X 300	Anodised Silver
	WA-POM90 N	900 X 300	
	WA-POM120 N	1200 X 300	

FURNITURE LIGHTS LED - 24V

Linear Recess 9mm

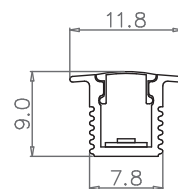
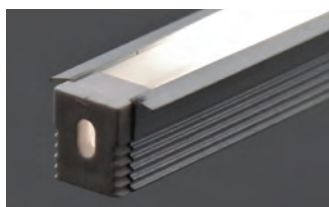
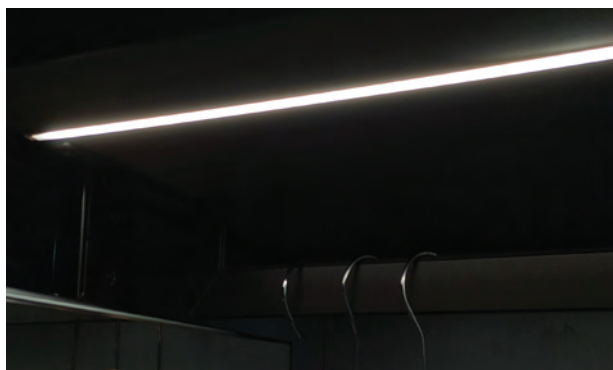

ITEM	CODE	SIZE (MM)	FINISH
Linear Recess 9mm	L-LR9-412	24V/4.8W/412	Anodised Silver
	L-LR9-562	24V/6.5W/562	
	L-LR9-862	24V/10W/862	

Linear Recessed Slim 8 mm with PIR sensor

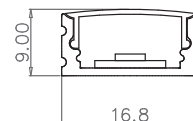
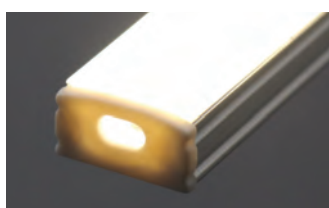

ITEM	CODE	SIZE (MM)	FINISH
Linear Recessed Slim 8mm With PIR sensor	L-LRS8-421	24V/6W/412	Anodised Silver
	L-LRS8-562	24V/8W/562	
	L-LRS8-862	24V/12W/862	

Linear Recessed 15 mm with PIR sensor

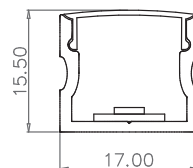
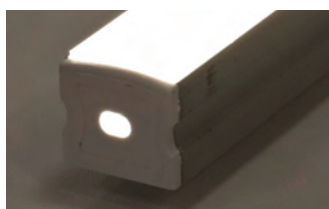

ITEM	CODE	SIZE (MM)	FINISH
Linear Recessed 15mm With PIR sensor	L-LR15-412	24V/6W/412	Anodised Silver
	L-LR15-562	24V/8W/562	
	L-LR15-862	24V/12W/862	

Linear 2 way Glass 8 mm with Door Trigger 2 part sensor

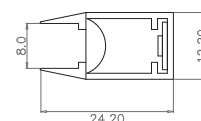
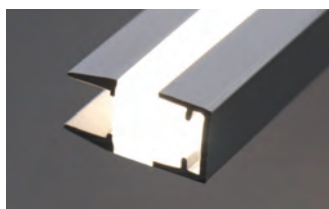

ITEM	CODE	SIZE (MM)	FINISH
Linear 2 Way Glass 8mm With Door Trigger 2 Parts Sensor	L-L2G8-412	24V/6W/412	Anodised Silver
	L-L2G8-562	24V/8W/562	
	L-L2G8-862	24V/12W/862	

FURNITURE LIGHTS LED - 24V

Linear Two Way 18mm - With Hand Shake Sensor

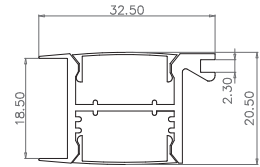
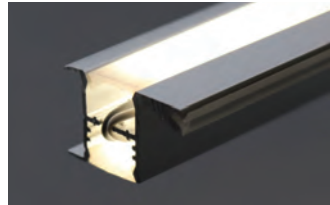

ITEM	CODE	SIZE (MM)	FINISH
Linear Two Way 18mm - With Hand Shake Sensor	L-L218H-412	24V/6W/412	Anodised Silver
	L-L218H-562	24V/8W/562	
	L-L218H-862	24V/12W/862	

Linear Wardrobe Oval with Door Trigger 2 part sensor

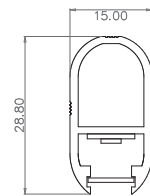
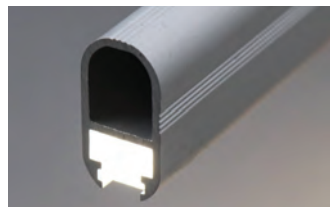

ITEM	CODE	SIZE (MM)	FINISH
Linear Wardrobe Oval With Door Trigger 2 part sensor	L-LWO-412	24V/6W/412	Anodised Silver
	L-LWO-562	24V/8W/562	
	L-LWO-862	24V/12W/862	

Linear 2 Way Angular 18mm - With Door Trigger Two Part Sensor

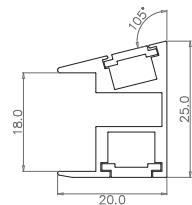
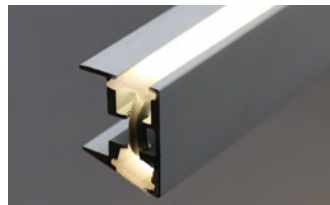

ITEM	CODE	SIZE (MM)	FINISH
Linear 2 Way Angular 18mm - With Door Trigger Two Part Sensor	L-L218A-412	24V/6W/412	Anodised Silver
	L-L218A-562	24V/8W/562	
	L-L218A-862	24V/12W/862	

3 Way Distributor

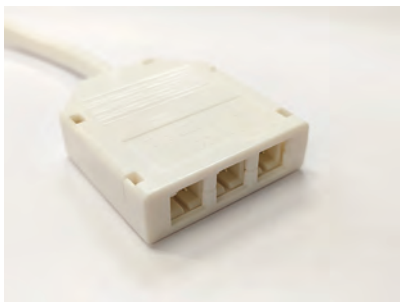

CODE : L-D3

6 Way Distributor

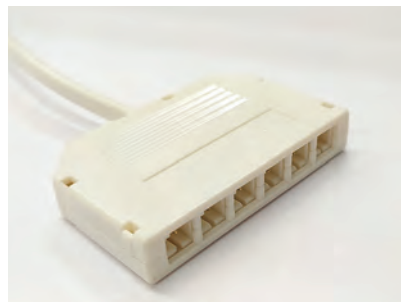

CODE : L-D6

Power Supply Unit



CODE : PSU-2425



Simplifying lives.



EBCO Pvt.Ltd.

402 - 405 / 502, Hyde Park, Saki Vihar Road, Mumbai - 400072, India.

Tel : +91 22-67837777 | Fax : +91 22 66920700 | Email : info@ebco.in

National Display Centres: **Ahmedabad:** 079-26880478, **Bangalore:** 080-25503372, **Chennai:** 044-24611937, **Cochin:** 0484-2333394, **Coimbatore:** 0422-2548316, **Delhi:** (Moti Nagar) 011-49843306, (Okhla) 011-40234984, **Guwahati:** 09435111409, **Hyderabad:** 040-23557252, **Indore:** 06262875491, **Jaipur:** 0141-2390773, **Kolkata:** 033-46034171/72, **Lucknow:** 09506464066, **Mumbai:** 022-67837700, **Nagpur:** 0712-2221637, **Nashik:** 8380074994, **Pune:** 020-26456787, **Raipur:** 07773014904, **Surat:** 0261-2234677 **City Display Centres:** **Bhopal:** 09691171147, **Ghaziabad:** (Sahibabad) 09643300730/2, **Madurai:** 0452-4208072, **Mumbai:** (Malad) 09326774528, **Tiruchirappalli:** 09176612337, **Trivandrum:** 9645006995, **Mysore:** 9243502500 / 9741649062.

www.ebco.in

August 2021